

GPSMAP® 276C

chartplotting receiver

owner's manual



© Copyright 2004 Garmin Ltd. or its subsidiaries

Garmin International, Inc.

1200 East 151st Street, Olathe, Kansas 66062, U.S.A.

Tel. 913/397.8200 or 800/800.1020

Fax 913/397.8282

Garmin (Europe) Ltd.

Unit 5, The Quadrangle, Abbey Park Industrial Estate, Romsey, SO51 9DL, U.K.

Tel. 44/0870.8501241

Fax 44/0870.8501251

Garmin Corporation

No. 68, Jangshu 2nd Road, Shijr, Taipei County, Taiwan

Tel. 886/2.2642.9199

Fax 886/2.2642.9099

All rights reserved. Except as expressly provided herein, no part of this manual may be reproduced, copied, transmitted, disseminated, downloaded, or stored in any storage medium, for any purpose without the express prior written consent of Garmin. Garmin hereby grants permission to download a single copy of this manual onto a hard drive or other electronic storage medium to be viewed and to print one copy of this manual or of any revision hereto, provided that such electronic or printed copy of this manual must contain the complete text of this copyright notice and provided further that any unauthorized commercial distribution of this manual or any revision hereto is strictly prohibited.

Information in this document is subject to change without notice. Garmin reserves the right to change or improve its products and to make changes in the content without obligation to notify any person or organization of such changes or improvements. Visit the Garmin Web site (www.garmin.com) for current updates and supplemental information concerning the use and operation of this and other Garmin products.

Garmin[®], GPSMAP[®], AutoLocate[®], TracBack[®], BlueChart[®], City Select[®], and MapSource[®] are registered trademarks of Garmin Ltd. or its subsidiaries and may not be used without the express permission of Garmin.

December 2004

Part Number 190-00335-00 Rev. B

Printed in Taiwan

INTRODUCTION

Preface

Thank you for choosing the Garmin® GPSMAP® 276C, which utilizes the proven performance of Garmin GPS and full-featured mapping to create an unsurpassed portable marine navigation chartplotter and automobile navigation device. Take a moment to compare the contents of this package with the packing list on the outside of the box; if any pieces are missing, contact your Garmin dealer immediately.

About This Manual

To get the most out of your new navigation system, take time to read this manual and learn the operating procedures for your unit. This manual is organized into the following eleven sections:

The **Introduction** contains the Table of Contents. The **Getting Started** section provides an overview of the unit, how to turn the unit on, and how to simulate navigation.

The **Basic Operation in Marine Mode** section provides you with information about navigating with the GPSMAP 276C in Marine Mode. The **Marine Mode Pages and Features** section reviews the main pages and features in Marine Mode, such as using DSC and Man OverBoard.

The **Basic Operation in Automotive Mode** section provides you with information about navigating with the GPSMAP 276C in Automotive Mode. The **Automotive Mode Pages and Features** section reviews, in detail, the main pages and features in Automotive Mode, such as the Trip Data page and creating waypoints.

The **Additional Page and Features** section describes pages and features found in the Main Menu.

To learn how to change the settings of the GPSMAP 276C, read the **Customizing Your GPSMAP 276C** section.

If you have a Garmin Sounder Module connected to you GPSMAP 276C, refer to the **Setting Up and Using Sonar** section.

The **Appendix** contains specifications, optional accessories, maintenance information, and other product information. **Read the Safety Information for information about installing and using your GPSMAP 276C safely and responsibly.**

An **Index** is provided at the end of the manual for reference.

Table of Contents

Introduction	i
Preface	i
About This Manual	i
Care Information	vi
Cleaning the Unit.....	vi
Storing the GPSMAP 276C.....	vi
Immersing the Unit in Water	vi
Getting Started	1
Unit Overview	1
Charging the GPSMAP 276C	2
Information about Charge Mode	2
Turning On the GPSMAP 276C	3
Adjusting the Backlight and Volume.....	3
Getting Satellite Signals	4
Viewing GPS Status with the GPS page.....	4
Receiver Status	5
GPS Options	6
GPS Tips.....	6
Learning about the Keypad	7
Using the GPSMAP 276C	8
Understanding Features	8
Selecting Options and Entering Data.....	9
Using the Databases.....	10
Simulated Basic Navigation	11
Activating Simulator Mode	11

Entering a New Location.....	11
Simulating Navigation	12
Basic Operation In Marine Mode	14
Marine Mode Page Sequence	14
Navigating in Marine Mode	15
Initiating Navigation.....	15
Man OverBoard (MOB)	17
Finding an Item	18
Using the Find From Feature.....	18
Recently Found Items.....	19
Viewing the Information Page.....	20
Find Menu Options.....	20
Creating and Using Routes	21
Creating a Route	21
Navigating a Saved Route	22
Editing a Route	23
Using the Route Tab Options.....	25
Manually Transitioning to the Next Waypoint	25
Creating and Using Waypoints	26
Marking Your Present Position.....	26
Creating Waypoints Using the Map.....	27
Creating a Waypoint by Entering Coordinates	28
Reviewing a Waypoint.....	29
Adding a Waypoint to a Route.....	30
Averaging the Waypoint's Location	30
Projecting a Waypoint.....	31
Editing a Waypoint	32

Organizing Waypoints into Categories	33	Highway Page Options	51
Deleting Waypoints	34	Active Route Page	52
Proximity Points	35	Active Route Page Options	52
Managing Your Tracks	37	Position Data Page	53
Setting up and Saving your Tracks	37	Position Data Page Options	53
Saved Tracks	39	DSC	54
Navigating a Saved Track	40	Understanding Distress Calls	54
TracBack Tips	40	Understanding Position Reports	54
Following a Marine Route	41	Receiving DSC Calls	55
See Your Route on the Map Page	41	DSC Call List	55
View Your Heading with the Compass Page	41	DSC Log	56
View Your Path on the Highway Page	41	Receiving a Position Report or Distress Call	56
See Your Progress on the Active Route Page	42	DSC Directory	56
Watch Your Trip Data on the Position Data Page	42	Making a Distress Call	57
Marine Mode Pages and Features	43	Setting up DSC	57
Map Page	43	Basic Operation In Automotive Mode	58
Map Orientation	43	Automotive Mode Page Sequence	58
Zooming In and Out of the Map	44	Navigating in Automotive Mode	59
Panning the Map	45	Initiating Navigation	59
Clearing Unwanted Details from the Map	46	Following a Saved Route	61
Measuring Distance	47	Stopping and Resuming Navigation	61
Compass Page	48	Editing Your Route	62
Turning On the Compass Page	48	Entering Custom Avoids	62
Compass Page Options	48	Creating a Detour	63
Using the Marine Timer	49	Adding and Editing Stops (Via Points)	63
Highway Page	50	Following an Automotive Route	64
Using the Highway Page	50	Track your Progress with the Map Page	64

Watch your Trip Data.....	64
See your Next Turn with the Current Route Page.....	64
Automotive Mode Pages and Features	65
Map Page.....	65
Current Route Page.....	66
Saving the Current Route	66
Trip Computer Page	67
Trip Computer Page Options Menu.....	67
Additional Pages and Features	68
Setting Alarms	68
Navigation (Nav) Alarms	68
System Alarms.....	69
Sonar Alarms	69
Using the Calendar.....	70
Day View	70
Week View.....	70
Month View	70
Calendar Options.....	70
Viewing Celestial Information	71
Tide Tab	71
Sun & Moon Tab	73
Hunt & Fish Tab	74
Viewing Messages.....	75
Viewing the Temperature	76
Changing the Temperature Display	76
Reset the Temperature Graph	76

Customizing Your GPSMAP 276C	77
Setting up the System.....	77
Adding a Welcome Message.....	77
Changing the Page Layout and Data Fields.....	78
Setting up the Map Page.....	78
Additional Map Data Displayed.....	79
Changing the Display	80
Changing the Sounds.....	81
Changing the System Settings	82
Setting the Timers.....	83
Changing the Time.....	83
Customizing the Units	84
Restoring Defaults	84
Customizing the Routing and Guidance Settings.....	85
Road Routing Settings.....	85
Guidance Settings.....	86
Changing the Location Settings	87
Changing the Location Format.....	87
Selecting a Different Map Datum.....	87
Selecting a Different Heading Reference	87
Changing the Data Format	88
Advanced NMEA Output Setup	90
Setting up and Using Sonar	91
Showing Sonar on the Map Page.....	91
Using the Sonar Page	92
Adjusting the Sonar Page	93

Adjustment Options	93	Learning about GPS	108
Resizing the Split Screen	95	Common GPS Terms	108
Using the Pointer on the Sonar Page	95	What is Differential GPS (DGPS)?	108
Setting up the Sonar	96	Differential Field	108
Calibrating the Water Speed	97	What is WAAS?	109
Setting up the Sonar Display	98	LORAN TD Setup	110
Understanding Sonar	99	LORAN TD Feature	110
Understanding the Sonar Display	99	Using the LORAN TD Format	110
Transducer Coverage	100	Map Datums and Location Formats	112
Whiteline	101	What are a Map Datum and which should I use?	112
Thermoclines	101	What is a Location Format and which should I use?	112
Appendix	102	Digital Selective Calling (DSC)	113
Specifications	102	What is a Maritime Mobile Service Identity (MMSI) number? ..	113
Physical Specifications	102	How are MMSI assignments obtained?	114
Power	102	Non-Federal Users in the United States	114
Performance	102	Federal Users in the United States	114
Accuracy	102	Users Outside the United States	114
Optional Accessories	103	Users In Canada	114
Installation Information	104	How can Garmin help you with DSC?	114
Connecting the Power/Data Cable	104	Messages	115
Connecting Your GPSMAP 276C to a Computer	105	Data Field Options	116
Information about USB Drivers	105	Safety and Product Information	118
Using xImage for Customized Waypoint Icons	106	Index	123
Installing and Removing Data Cards	106		
Interfacing	107		
Removing the Antenna	107		

Care Information

To resolve problems that cannot be remedied using this guide, contact Garmin Product Support in the U.S.A. at 800/800.1020 or Garmin Europe at 44/0870.8501241.

Cleaning the Unit

The GPSMAP 276C is constructed of high quality materials and does not require user maintenance other than cleaning. Clean the unit using a cloth dampened with a mild detergent solution. Avoid chemical cleaners and solvents that may damage plastic components. Wipe the unit dry with a dry cloth.

Storing the GPSMAP 276C

Do not store the GPSMAP 276C where prolonged exposure to temperature extremes may occur (such as in the trunk of a car), as permanent damage may result. User information, such as waypoints and routes, is retained in the unit's memory without the need for external power. It is always a good practice to back up important user data by manually recording it or downloading it to a PC (transferring it to MapSource).

Immersing the Unit in Water

The GPSMAP 276C is waterproof to IEC Standard 60529 IPX7. It can withstand immersion in 1 meter of water for 30 minutes. Prolonged submersion can cause damage to the unit. After submersion, wipe and air dry the unit before reuse or charging.

GETTING STARTED

Unit Overview

The GPSMAP 276C is an all-in-one, versatile color chartplotter and automobile navigator—perfect for land or water. This portable GPS navigator features a 256-color TFT display that is easy to read in bright sun, a built-in basemap, and auto routing to provide you with automatically generated turn-by-turn directions.

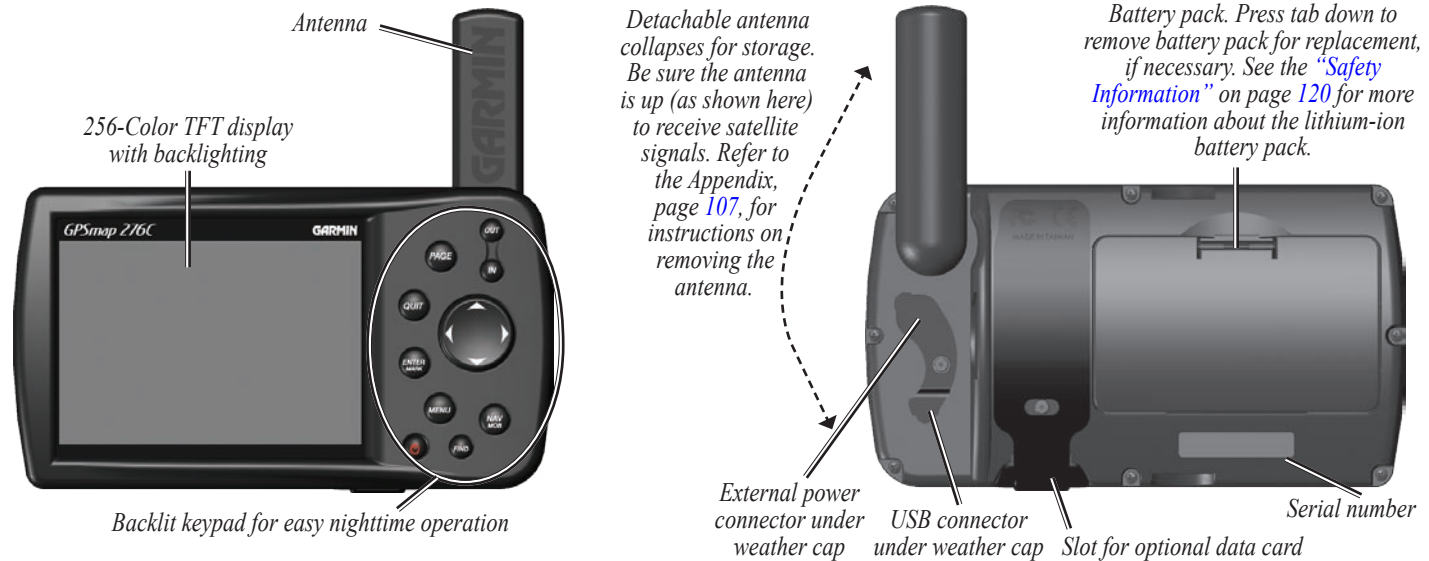

Charging the GPSMAP 276C

Before using the unit, you may need to charge the battery in the GPSMAP 276C. Simply plug the unit into an external power source to charge. You can use the unit while it is charging.

To charge the unit's battery:

1. Lift the rubber weather cap to expose the power connector on the back of the unit. Refer to the image on page 1 for connector location.
2. Align the notches and push the plug into the connector until fully seated.
3. Plug the 12 Volt adapter into an available AC outlet, or cigarette lighter receptacle if you have a Cigarette Lighter Adapter. Use care when routing the cable; be certain that it does not interfere with vehicle operation.

The unit begins charging as soon as external power is applied. Placing the unit in Charge Mode, as discussed below, charges the unit more quickly than when the unit is turned on and reduces draw on the vessel/vehicle battery.

Information about Charge Mode

Applying external power to the GPSMAP 276C automatically turns on the unit for full operation. If the battery is present and needs to be charged, the external power source charges the battery while the unit is in use.

If you do not want to use the unit, but you would like to charge the battery, you can put the unit into Charge Mode. Connect the unit to an external power supply. Press and hold the red **POWER** key. Instead of completely turning off, the unit now goes into Charge Mode, as shown below.



Charge Mode



NOTE: While in Charge Mode, the unit draws a small amount of current from the vessel/vehicle battery. To avoid discharging the vehicle's battery, disconnect the external power cable from the GPSMAP 276C when not in use for several days.

After using the unit a lot, you may notice that the lithium-ion battery in the unit is not holding a charge any more. This is common for lithium-ion batteries. Contact Garmin or your Garmin Dealer to order a Battery Pack replacement if you are experiencing charging issues with your battery.

Turning On the GPSMAP 276C

The first time you turn on your new GPSMAP 276C, the receiver must collect satellite data and establish its present position. To ensure proper initialization, the GPSMAP 276C is shipped from the factory in AutoLocate mode, which allows the receiver to “find itself” anywhere in the world. Before you turn on the unit to start initialization, be sure that the antenna is rotated up as shown on page 1, and it has a clear and unobstructed view of the sky to receive satellite signals.

To turn on and off the GPSMAP 276C:

1. Press and hold the red **POWER** key. When the unit powers on, a tone sounds and the Warning page displays.



Warning Page

2. Read and be sure you understand the warning. If you have external devices connected, they are listed here. Press **ENTER** to continue.

3. To turn off the GPSMAP 276C, press and hold the red **POWER** key again.

Adjusting the Backlight and Volume

You may want to adjust the backlight to see the display better. If you are using the optional External Speaker with 12/24-Volt Adapter Cable with the GPSMAP 276C, you may want to adjust the volume level of the speaker.

To adjust the backlight level or volume:

1. Press and quickly release the **POWER** key.
2. Press the **Rocker** key Up to increase the brightness or Down to decrease. Press Right to raise the volume or left to lower.
3. Press **ENTER** or **QUIT** to close the Backlight/Volume adjustment window. Press **MENU** to view the options menu.

Battery Time Remaining and Power Source Indicator

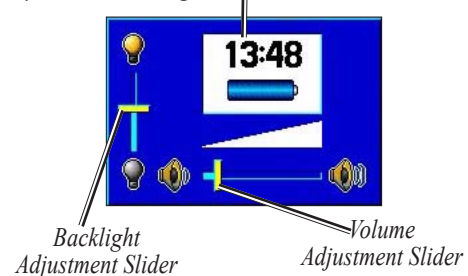

Getting Satellite Signals

After you turn on the GPSMAP 276C, the unit automatically begins searching for satellites. The GPS page is displayed while the unit is gathering satellite signals and acquiring a fix, which should take only a few minutes. While the GPSMAP 276C is getting satellite signals, the GPS page displays the status as “Acquiring Satellites.”

It may take a few minutes to acquire satellites and display your current location on the map. Be patient as the unit acquires satellite data. To get signals more quickly, be sure the antenna is raised to the up position shown in the image on page 1.

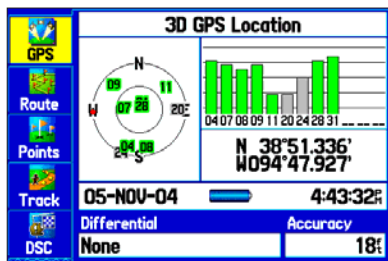

GPS Page



NOTE: While acquiring satellites, the Map page may display the wrong location, such as China. This does not mean your unit has the wrong data loaded; it simply means you need to wait a few more minutes to acquire satellites and find your current location.

Viewing GPS Status with the GPS page

The GPS page provides a visual reference of satellite acquisition, receiver status, and accuracy. The sky view and signal strength bars give an indication of what satellites are visible to the receiver and whether they are being tracked.

As the receiver locks onto satellites, a signal strength bar appears for each satellite in view, with the appropriate satellite number underneath each bar. The numbers displayed below each bar represent the particular satellite that is being received. Numbers above 33 indicate WAAS satellites.

The sky view shows a birds-eye view of the position of each satellite relative to the receiver’s last known position. The outer circle represents the horizon (north up), the inner circle represents 45° above the horizon, and the center point represents a position directly overhead. You can also set the sky view to a Track Up configuration, causing the top of the sky view to align along your current track heading. Press **MENU** to change the configuration of the sky view.

A power source indicator shows the unit is operating off battery power (🔋), that the unit is charging (🔋⚡), or that an external power source is in use (🔌).

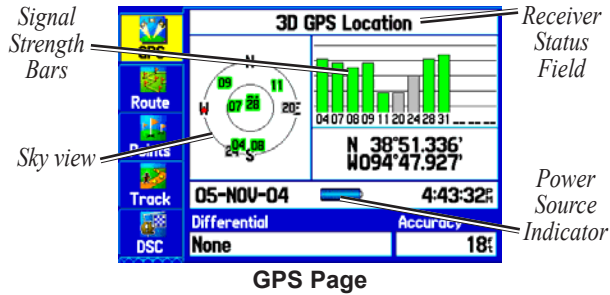

GPS Page

The progress of satellite acquisition is shown in three stages:

- **No signal strength bars**—the receiver is looking for the satellites indicated.
- **White signal strength bars**—the receiver has found the satellite and is collecting data.
- **Green signal strength bars**—the receiver has collected the necessary data from this satellite.

As soon as the GPSMAP 276C has collected the necessary data from the best satellites in view to calculate a fix, the status field indicates the status of the receiver. The unit then updates the position, date and time.

Receiver Status

The Receiver Status field displays one of the following conditions:

- **Searching the Sky**—the receiver is looking for satellites.
- **AutoLocate**—the receiver is looking for any satellite whose almanac has been collected, which can take up to 5 minutes.
- **Acquiring Satellites**—the receiver is looking for and collecting data from satellites visible at its last known or initialized position, but has not acquired a fix.
- **2D GPS Location:** At least three satellites have been acquired and a two-dimensional position fix has been calculated. “2D Differential” appears when you are receiving DGPS corrections in 2D mode and a “D” appears on the strength bar of satellites being corrected.
- **3D GPS Location:** At least four satellites have been acquired and a three-dimensional fix has been calculated. “3D Differential” appears when you are receiving DGPS corrections in 3D mode and a “D” appears on the strength bar of satellites being corrected.
- **Lost Satellite Reception**—the receiver is no longer tracking enough satellites for a 2D or 3D fix.
- **Receiver Not Usable**—the receiver is unusable, possibly due to interference or abnormal satellite conditions. Turn the unit off and back on to reset.
- **Simulating GPS**—the receiver is in simulator mode.
- **GPS Off**—the GPS receiver is turned off.

GPS Options

Press **MENU** two times to open the Main Menu. Use the **Rocker** key to highlight GPS. Press **MENU** to open the options menu.



GPS Page Options Menu

Start/Stop Simulator—activates and deactivates simulator mode, which is particularly helpful when learning how to use your unit.

WAAS On—enables WAAS capability. Refer to page 109 of the “Appendix” for more information about WAAS.

Track/North Up—orients the sky view display on the GPS page to north up or track up.

New Altitude—allows you to manually enter your altitude.

New Location—allows you to enter a new location automatically or using the map.

GPS Tips







While the receiver is gathering information, your location on the map may display as different from where you actually are located. Be patient; as soon as the receiver gathers enough satellite information, your proper location is displayed on the map.

Any time you have traveled more than 600 miles with the GPS receiver turned off, the receiver may take longer than normal to initialize and find your location.

The GPS receiver can lose satellite signals due to interference from such items as buildings, tunnels, and heavy tree cover. Monitoring the GPS status is recommended.

To learn about GPS, refer to “[Learning about GPS](#)” on page 108.

Learning about the Keypad

-  Press the **IN** key to adjust the map scale to show a smaller area with more detail (zoom in).
-  Press the **OUT** key to adjust the map scale to show a larger area with less detail (zoom out).
-  Press the **PAGE** key to cycle through the main pages in sequence and exit a submenu page. Press and hold to switch between Marine and Automotive Modes.
-  Press **QUIT** to cycle the unit through the main pages in reverse sequence, revert to the previous value in a data entry field, or cancel an unintended function.
-  Press **ENTER** to select a highlighted option. When entering data, it allows you to initiate entry and to accept the selected value. Press and hold for more than one second to mark your current location as a waypoint.
-  Press **MENU** to display a menu of available options for the current page. Press **MENU** twice to display the Main Menu.



Press the **NAV/MOB (Navigate/Man OverBoard)** key to display the Navigation Menu. While in Marine Mode, press and hold for more than one second to activate the Man Overboard (MOB) function.

While in Automotive Mode, press and hold to display the Next Turn page and announce the next turn when using the external speaker.



Press the **FIND** key to quickly search for and access user waypoints, cities, points of interest, services and other items used for navigation.



Press and hold the **POWER** key for more than one second to turn the unit on and off. Briefly press and release to adjust the backlighting and external speaker volume.



Use the **Rocker** key to highlight options and to enter data. Also use to pan the arrow  on the Map page.

Using the GPSMAP 276C

This section explains how to enter and select information with the GPSMAP 276C.

Understanding Features

The GPSMAP 276C advanced keypad system is designed to allow quick, convenient selection of navigation options and data entry. As you progress through this *Owner's Manual*, you will be directed to press a specific key or highlight a field on the screen. When you are directed to press a key, you should press and quickly release the key. If the key needs to be held down for a period of time to activate a secondary function, the instructions will tell you to do so. When a field is selected on the screen, it is highlighted in yellow. The position of the highlight is controlled by the **Rocker** key.

The following terms are used throughout this manual:

Highlight—move the highlighted area on the screen Up, Down, Left, or Right with the **Rocker** key to select individual fields. Moving the highlight to a given location allows you to make a selection, begin data entry, or scroll through a list.

Field—the location on a page where data or an option may be entered and displayed. Select (highlight) a field using the **Rocker** key to begin entering data or selecting options.

On-Screen Button—similar to “field.” Use the **Rocker** key to highlight a button and press **ENTER** to select the button.

Scroll Bar—when viewing a list of items too long to display on the screen, a scroll bar appears along the right side of the list. The position of the scroll bar indicates which portion of the list is currently displayed. To scroll through a list, press Up or Down on the **Rocker** key.

Default—the factory setting saved in the unit's memory. You can change the settings as you like, but you can also revert to the factory (default) settings when you select **Restore Defaults**.

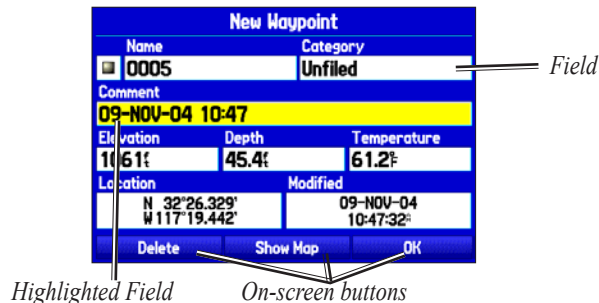

Selecting Options and Entering Data

To enter data and select options, use the **Rocker** key to highlight, select, or choose an item in a list or a field on the screen. Use the **ENTER** key and the **Rocker** key to select options, enter names and numbers in data fields, and activate your selections.

To select and activate an option:

1. With any page displayed, press **MENU**. An options menu appears with a list of optional features for that page.
2. Use the **Rocker** key to move the highlight Up, Down, Right, or Left on the menu to your desired selection.
3. Press **ENTER** to activate the feature. Another window may then appear with more options. If so, select the desired option and press **ENTER** again.

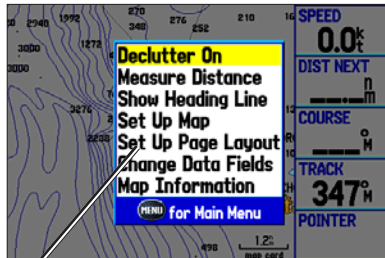

Selecting an option from an options menu

To exit a menu or return to the previous setting:

Press **QUIT**. The **QUIT** key moves backwards through your steps. Press **QUIT** repeatedly to return to the starting page.

To select and activate an on-screen button:

1. On a page with on-screen buttons, use the **Rocker** key to highlight the desired on-screen button.
2. Press **ENTER**.



On-Screen Button

To practice entering data, try marking a waypoint and customizing one of the waypoint properties, such as the waypoint name.

To mark your current location as a waypoint, press and hold **ENTER/MARK** until the New Waypoint page appears.

To enter data in a data field:

1. Use the **Rocker** key to highlight the desired data field and press **ENTER** to activate the field.
2. Press Up or Down on the **Rocker** key to select characters. Press Right to move to the next character or press Left to move back to the previous character. If there are two lines of data, keep pressing Right to drop to the next line.

New Waypoint		
Name	Category	
<input type="checkbox"/> CABIN_____	Unfiled	
Comment		
09-NOV-04 10:44		
Elevation	Depth	Temperature
1047'	24.8'	60.6'
Location		Modified
N 32°48.702'		09-NOV-04
W 117°08.411'		10:44:51'
Delete	Show Map	OK

Entering data



TIP: To clear the entire data field, highlight the left-most character field and press Left once more on the **Rocker** key.

3. After entering the desired data, press **ENTER**.

Not all fields are programmable. When you are on a page with fields that are not selectable, the highlight skips over them.

Using the Databases

Optional Garmin Data Cards and MapSource CD-ROMs enhance the versatility of your GPSMAP 276C. With optional MapSource City Select data, you can view listings of nearby restaurants, lodging, shopping centers, attractions and entertainment, and even retrieve addresses and phone numbers for any listed location.

The included USB Interface Cable or an optional PC Interface Cable (with a serial connector) is used to transfer MapSource CD-ROM data to the optional Data Card.

Refer to the Garmin Web site at <http://www.garmin.com/cartography/> for compatible MapSource products.

Simulated Basic Navigation

To help you get to know your GPSMAP 276C, you can use the unit in Simulator Mode. Simulator Mode is also helpful for practicing with the unit indoors or when no satellite signals are available. All waypoints and routes created in Simulator Mode are retained in memory for future use. The following section describes how to use simulator mode and walks you through some basic navigation using the simulator.

Activating Simulator Mode

You can activate Simulator Mode from the Setup tab or the GPS tab of the Main Menu.

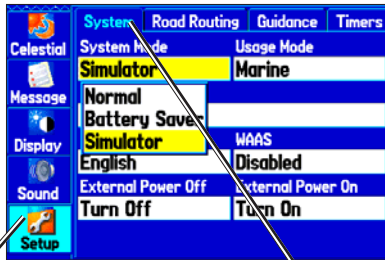

Setup tab of Main Menu

System tab



NOTE: Do not attempt to navigate using Simulator Mode. When the unit is set to Simulator Mode, the GPS receiver is turned off. Any Satellite Signal Strength Bars displayed are only simulations and do not represent the strength of actual satellite signals.

To put the unit into Simulator Mode using the GPS tab:

1. Press **MENU** twice to display the Main Menu.
2. Highlight **GPS** from the vertical menu.
3. Press **MENU** to open the GPS tab options menu.
4. Highlight **Start Simulator** and press **ENTER**.

Entering a New Location

From the GPS options menu you can also enter a New Location to simulate from.

To enter a New Location using the map:

1. Press **MENU** twice and highlight **GPS** from the vertical menu.
2. Press **MENU** to open the options menu.
3. Highlight **New Location** and press **ENTER**.
4. Highlight **Use Map** and press **ENTER**.
5. Use the **Rocker** key to move the panning arrow to the desired location on the map and press **ENTER**.

Simulating Navigation

The main purpose of using a GPS receiver is for navigating to a known position. To get a feel for navigating with the GPSMAP 276C, it is a good idea to practice navigation in Simulator Mode. For this simulation we have set our location to the San Diego coast.

To find a marine destination:

1. Be sure the GPSMAP 276C is set to Simulator Mode (see “Activating Simulator Mode” on the previous page).
2. Press the **FIND** key.
3. Highlight **Tide Stations** and press **ENTER**.
4. Use the **Rocker** key to select a nearby Tide Station and press **ENTER**. For our example, we selected Point Loma.
5. With **Go To** highlighted on the Tide Station Information Page, press **ENTER**.

To simulate navigation to the marine destination:

1. Follow the previous steps to find a destination. The GPSMAP 276C switches to the Map page. A magenta line shows the direct route from your current location to your destination. If desired, press **IN** or **OUT** to adjust the zoom level.
2. Press the **PAGE** key twice to display the Compass page.

3. Press Up on the **Rocker** key to increase the speed to 40 kt. (which is the desired speed setting). Press the **Rocker** key Right or Left to simulate steering.
4. Press **QUIT** to return to the Map Page. Press **IN** to adjust the zoom level. Observe the movement of the position marker (triangle) as the unit simulates navigation.
5. If desired, press **PAGE** or **QUIT** to view the simulated navigation on the other main pages.

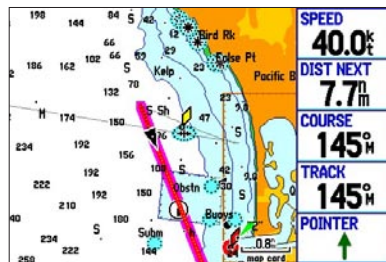

Simulated navigation displayed on the Map Page (Marine Mode)

Now we will simulate navigation in the Automotive Mode. To switch between Marine and Automotive Mode, press and hold the **PAGE** key. Use the **Rocker** key to select **Automotive** and press **ENTER**.

To find a land destination:

1. Be sure the GPSMAP 276C is set to Simulator Mode (see “Activating Simulator Mode”).
2. Press the **FIND** key.
3. Highlight **Cities** and press **ENTER**.
4. Use the **Rocker** key to select a nearby city and press **ENTER**. For our example, we selected National City, CA.
5. With **Go To** highlighted, press **ENTER**.

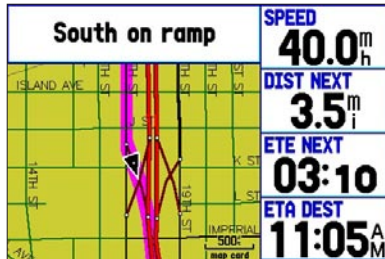

Simulated navigation displayed on the Map Page (Automotive Mode)

To simulate navigation to the Automotive destination:

1. Follow the previous steps to find a destination city. The GPSMAP 276C switches to the Map page. A magenta line shows the turn-by-turn route from your current location to your destination.
2. The GPSMAP 276C automatically adjusts your speed to “move” you along your route. Observe the movement of the position marker (triangle) as the unit simulates navigation. If desired, press **IN** or **OUT** to zoom.
3. If desired, press **PAGE** or **QUIT** to view the simulated navigation on the other main pages.

↑	3.3 ^m	Exit right to W 8th St	02:53 11:02 ^A
↗	3.5 ^m	Keep right on ramp to W 8th St	03:08 11:02 ^A
↘	3.8 ^m	Turn right on National City Blvd	03:35 11:03 ^A
↙	4.5 ^m	Turn left on E 20th St	04:48 11:04 ^A
↖	4.7 ^m	Arrive at National City on left	06:01 11:05 ^A

Simulated Current Route Page (Automotive Mode)

When you are ready to navigate on your own, turn the Simulator off.



TIP: You can activate and deactivate the Simulator through the Setup tab or GPS tab options menu of the Main Menu.

BASIC OPERATION IN MARINE MODE

This section explains some of the more common operations you will perform with your GPSMAP 276C, such as navigating to a destination.

To switch usage modes:

1. Press and hold the **PAGE** button.
2. Use the **Rocker** key to select either **Automotive** or **Marine** and press **ENTER**.

Marine Mode Page Sequence

The GPSMAP 276C offers two usage modes, Marine Mode (default) and Automotive Mode. The main pages are linked together in a series that you can cycle through by pressing the **PAGE** key to move forward and the **QUIT** key to reverse. Each page also has an options menu that allows you to customize each page to your preferences and/or select features. To view the options menu, press the **MENU** key.

Marine Mode features five main pages: the Map, Compass, Highway, Active Route, and Position Data pages. The following examples show the main pages in Marine Mode with optional MapSource BlueChart detailed maps. The Marine Mode is the default mode for the GPSMAP 276C. This manual first addresses the page, such as the Map Page, as displayed in the Marine Mode. The manual then describes the page as shown in Automotive Mode.



Navigating in Marine Mode

There are several ways to begin navigating to a point:

- Select a point on the map and press the NAV key.
- Press the NAV key to activate a new route using the Find Menu, or activate a saved route or track.
- Press the FIND key to search for a particular item and create a route to it.

Marine Mode and Automotive Mode are very similar. Most of the features discussed here also apply to Automotive Mode.

Once you are actively navigating, you will see a magenta line that always runs from your current location to the destination on the Map page. You can use the Map page, Compass page, Highway page, and Position Data page to help navigate to your destination.

Initiating Navigation

There are several different ways to initiate navigation. Press the NAV key to open the Navigate Menu. Using one of the navigation options, you can quickly create a route to your destination. In Marine Mode, you can initiate Man OverBoard (MOB) navigation, which places a waypoint in the location and then navigates you back to that location. You can also initiate navigation through the Find Menu.

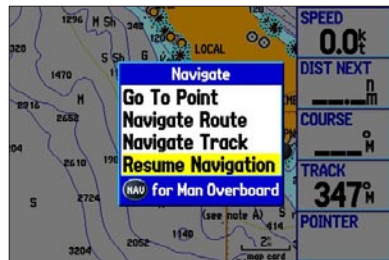

Navigate Menu in Marine Mode

Accessed by pressing NAV/MOB key

Press the NAV key to open the Navigate Menu:

Go To Point—allows you to select a waypoint or point of interest from the Find Menu to navigate to.

Navigate Route—allows you to select a route to navigate. You can also activate a saved route through the Routes tab of the Main Menu. For information about routes, refer to page 21.

Navigate Track (TracBack)—allows you to select a saved track to navigate. You can also activate a saved track through the Track tab of the Main Menu. For information about tracks, refer to page 37.

MOB (Man OverBoard)—creates a Man OverBoard waypoint and navigates to that location.

To go to a highlighted map item:

1. Use the **Rocker** key to highlight the item you would like to navigate to on the Map page.
2. Press **NAV**. **Go To <point name>** appears in the list of options and is automatically highlighted. If you have selected an area of the map that is not a map feature, **Go To MAP Point** is listed. Select **Go To <point name>** or **Go To MAP Point** and press **ENTER**.

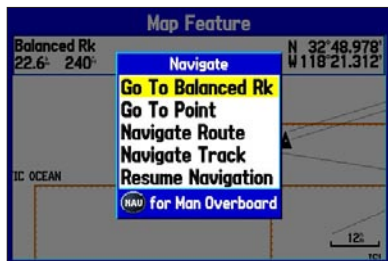

Navigate Menu

with Map Feature highlighted

3. Follow the magenta route created on the Map page. Follow the turn-by-turn route (auto-route) by using the Next Turns page and Current Route page. If you are using the external speaker, follow the voice prompts.

To activate new route using the Find Menu:

1. Press the **NAV** key to open the Navigate Menu.
2. Highlight **New Route** (or **Go To Point** when in Marine Mode) and press **ENTER** to open the Find Menu.
3. From the Find Menu, highlight **Waypoints** and press **ENTER**. (You may also choose to go to other points, such as **Cities** or **Tide Stations** from this list. The steps vary only slightly from those listed for **Waypoints**.)
4. Select a waypoint from the list then press **ENTER** to display the Waypoint page.

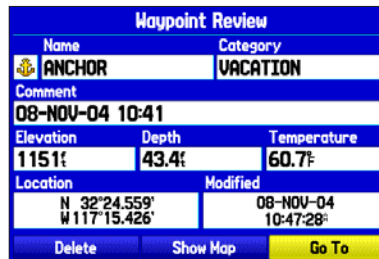

Waypoint Review Page

Activating a Go To using the Find Menu

5. The Waypoint page automatically opens. With the **Go To** button highlighted, press **ENTER** to begin navigation.

To search for an item and route to it:

1. Press **FIND** to open the Find Menu.
2. Using the **Rocker** key, highlight the desired category, such as **Cities**, and press **ENTER**.
3. Press **ENTER** and use the **Rocker** key to begin entering the letters contained in the item name. The list begins to sort by the items which contain the letters you are entering. Press **ENTER** when finished.

Food & Drink - From Current Location			
Containing A			
YA	El Embarcadero Restaurant	016M	6.1%
YA	J's American Grill	016M	6.1%
YA	Blue Wave Bar & Grill	017M	6.5%
YA	Bay Club Hotel	018M	6.6%
YA	Humphrey's By the Bay	018M	6.7%
YA	La Scala Italian Restaurant	014M	6.7%
YA	Old Venice Italian Restaurant	014M	6.7%
YA	Grandstand Pizza	013M	6.8%
YA	Con Pane Rustic Breads & C	013M	6.8%

Finding an item using the Containing field: The unit searches for items containing the letter combination you enter and displays them in the list.

3. Highlight the desired item from the list and press **ENTER**.
4. Press **ENTER** when the **Go To** button is highlighted.

For complete information about finding an item, refer to the [“Finding an Item”](#) section.

Man OverBoard (MOB)

The Man OverBoard function (MOB) lets you simultaneously mark your present position and create a direct route back to that position for quick response to emergency situations.

To activate the MOB function:

1. Press and hold the **NAV/MOB** key, or press the **NAV/MOB** key twice.
2. Press **ENTER** to confirm and begin navigating to the MOB position.

Once an MOB has been activated, an MOB waypoint with an international MOB symbol is created, and the unit begins actively navigating to that point. Use any of the Navigation Pages to guide you back to the MOB point. The MOB waypoint is stored in the waypoint list and may be deleted like any other waypoint.

Finding an Item

The Find Menu allows you to easily search the stored waypoints and points of interest. To open the Find Menu, press the **FIND** key.

The Find Menu is comprised of several default categories: Waypoints, Cities, Exits, Transportation, and Tide Stations. Additional categories are displayed depending on the optional BlueChart or MapSource data card in the unit.



Find Menu

Shown without additional BlueChart or MapSource maps installed

Follow the directions on page 17 to search for an item near your current location and then route to it.

Using the Find From Feature

The Find option also supports a “find from” feature that allows you to center your search around an item that you have just found. For example, you search for Restricted Areas and the search shows an “Anchoring Prohibited” search result. If you press **FIND** again, you will see “From Anchoring Prohibited” as the new search from point. You may also use the Find feature to center your search from any waypoint, route list entry, map item, or tide station. Highlight the item you want to find from and press the **FIND** key.

To find an item from another location on the map:

1. Open the Map page. Use the **Rocker** key to pan the arrow (pointer) to the desired location and press **FIND**.
2. The Find Menu opens, displaying “From Map Pointer.” The list of items is sorted to display items nearest the selected location. Using the **Rocker** key, highlight the desired category from the list and press **ENTER**.
3. Using the **Rocker** key, highlight the desired item from the list and press **ENTER**. The item’s information page automatically opens, allowing you to save the item as a waypoint, show the item on the map, or automatically create a route to (Go To) the item.

To find an item from another location:

1. From any page, press the **FIND** key.
2. Using the **Rocker** key, highlight the desired category from the list and press **ENTER**.
3. Press the **MENU** key to open the options menu.

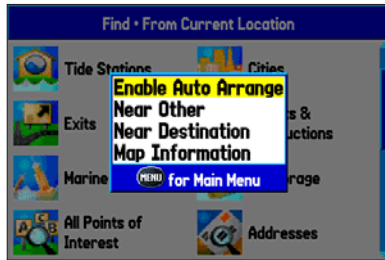
**Find From Options Menu**

4. Highlight **Near Other** and press **ENTER**. If you are actively following a route, you may also choose one of the other options listed in the Find From list, as shown below.
5. Select a reference position on the map and press **ENTER**. The list displays items nearest to the new map position.

To find an item near another item:

1. Press the **FIND** key.
2. From the Find Menu, highlight the item you want to Find From. For this example, we chose Coronado, CA.
3. Press the **FIND** key with the item highlighted. The Find Menu opens again with items near the previously-selected item, Coronado, CA in this example. Search for the desired item.

Recently Found Items

The Recently Found page displays a list of the items you have searched for or gone to recently.

To view recently found items:

1. Press the **FIND** key. The Find Menu opens.
2. Use the **Rocker** key to highlight **Recently Found**. Press **ENTER**. The Recently Found page opens.

Press **MENU** to display the options menu:

Show Find History—allows you to toggle between displaying the items you have searched for recently (Find History) and the items you have recently created a Go To for (Go To History).

Remove Point—removes the point that is highlighted in the list.

Viewing the Information Page

Each item on the map and each item listed in the Find Menu results list has an information page.

To view details about an item:

1. Highlight the desired point on the map or in the search results list and press **ENTER**.

An Information page appears with details about the item in a tabbed format. Depending on the type of item, additional options are available for viewing the item on the Map, viewing a tide chart, viewing the list of maps on your data card, and viewing the next item in the search results list.



Map Feature Information Page

Select **Save** to save feature as a waypoint

2. Press **PAGE** or **QUIT** to exit the information page. You can also highlight one of the on-screen buttons and press **ENTER** to perform that operation.

Find Menu Options

To view additional options for the Find Menu, press the **FIND** key and then press **MENU**. The following options are displayed:

Enable Auto Arrange—automatically arranges the Find Menu.

Disable Auto Arrange and **Restore Default** options appear when you select **Enable Auto Arrange**.

Near Other—allows you to select a new location from which to compile the Find items lists. Using the **Rocker** key, move the map arrow to the desired location and press **ENTER**.

Map Information—shows information about the detailed map data stored on the data card and allows you to select which maps are displayed on the Map page.

Additional selections are included in the options menu when you are navigating:

Near Next—compiles the Find items lists based upon the next turn in the route.

Near Destination—compiles the Find items lists based upon the route destination.

Near Current Route—compiles the Find items lists based upon the active route.

Creating and Using Routes

The GPSMAP 276C lets you create and store up to 50 reversible routes, with up to 300 points each.

Creating a Route

Use the Route tab of the Main Menu to create routes. Routes can be created in two ways. The first way is to select waypoints from the Find Menu, allowing you to see a list of the route points as you create the route. The second way is by selecting waypoints or map items from the Map page, allowing you to see each route point graphically on-screen as you create the route.

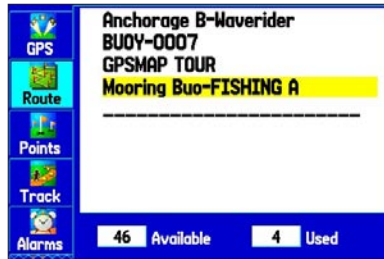

Route Tab Displaying the Route List

To create a route using the Find Menu:

1. Press **MENU** twice to display the Main Menu.
2. Use the **Rocker** key to highlight the **Route** tab.
3. Press **MENU** to display the Route options menu. Select **New Route** and press **ENTER**. Or, highlight the first available blank route slot and press **ENTER**.
4. The Route Review page automatically opens, displaying a blank route. Press **ENTER** to find items to add to the route.
5. The Find Menu opens. Using the methods discussed in the “[Finding an Item](#)” section beginning on page 18, select a point to add to your route. When you find an item, highlight **OK** and press **ENTER** to add the point to the route. Repeat until you have added all of the points to the route.

Route			
Anchorage B-Waverider			
Waypoint	Course	Distance	ETE
⚓ Anchorage Waverider	233M	0f	:-:-
	---M	12.9%	:-:-
		---	:-:-
Total	233M	12.9%	:-:-

Creating a new route on Route Review page

To create a route graphically:

1. Press **MENU** twice to display the Main Menu. Use the **Rocker** key to highlight the **Route** tab.
2. Press **MENU** to display the Route options menu. Select **New Route** and press **ENTER**.
3. Highlight the first blank slot in the Route List page and press **MENU**. Use the **Rocker** key to highlight **Edit on Map** and press **ENTER**.
4. Use the **Rocker** key to highlight the location you want to add and press **ENTER**.

If you have selected an area of the map that is not a feature or waypoint, a new waypoint is created for that location. Press **ENTER** on the New Waypoint page to save the location as a waypoint and continue adding points to your route. You can edit the properties of this waypoint as you can with any waypoint.

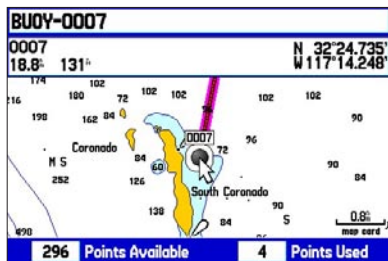

Creating a new route on the map

5. Repeat until you have added all points to the route.
6. When finished, press **QUIT** twice to return to the Route Review page. Or, press **MENU**, highlight **Edit as Text**, and press **ENTER** to view the Route Review page.

Navigating a Saved Route

The Navigate Route option allows you to easily select and activate a saved route.

To navigate a saved route:

1. In Automotive Mode, press the **NAV** key.
2. Use the **Rocker** key to highlight **Navigate Route** and press **ENTER**.
3. Highlight the desired route and press **ENTER**.

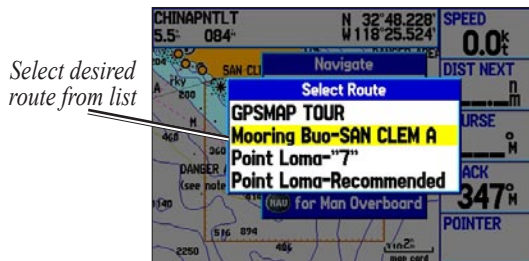

Select the route you want to take

Editing a Route

Once you have created a route, the Route Review page allows you to edit, change the name, and review route points of a selected route.

To change the name of the route:

1. Press **MENU** twice to open the Main Menu. Highlight the **Route** tab.
2. Use the **Rocker** key to highlight the name of the desired route and press **ENTER**.
3. With the Route Review page displayed, use the **Rocker** key to highlight the route name field at the top of the page and press **ENTER**.

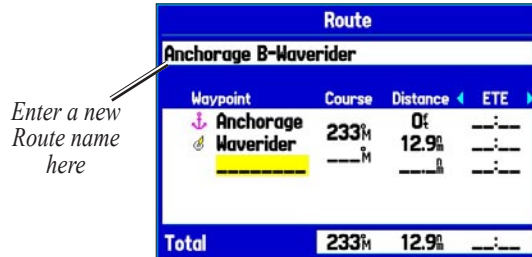

Route Review Page

4. Use the **Rocker** key to enter the desired route name. Then press **ENTER**.

To review individual route points:

1. Press **MENU** twice to open the Main Menu. Highlight the **Route** tab.
2. From the Route List page, use the **Rocker** key to highlight the name of the desired route and press **ENTER**.
3. From the Route Review page, highlight the desired point and press **ENTER**.
4. On the Point Review page, choose **Next** (highlight the next point on the route list), **Show Map** (show the point on a map window), or **Save** (save the point as a waypoint) and press **ENTER**. If the route point is a user waypoint, you may edit any of the waypoint properties on the Waypoint page (see the "Creating and Using Waypoints" section beginning on page 26 for details).

Once you are back on the Route Review page, the next point in the route is automatically highlighted. This allows you to review each point on the route by pressing **ENTER** repeatedly.

To add points to the route:

1. Press **MENU** twice to open the Main Menu. Use the **Rocker** key to select the **Route** tab.
2. Use the **Rocker** key to select the desired route and press **ENTER**.
3. Use the **Rocker** key to highlight the spot in the route that you want to add the new point. (The new point is added before the highlighted route point.) Press **MENU**.
4. Highlight **Insert Waypoint** and press **ENTER**. The Find Menu automatically opens for you to search for and select the point you want to add to the route.

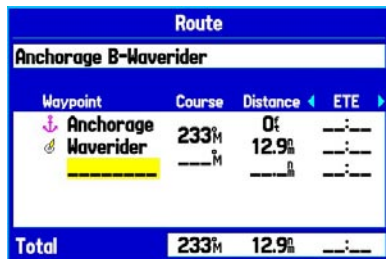

Route Review Page

5. In the point review page, highlight **OK** and press **ENTER** to add the new point to the route.

To edit the route on the map:

1. Press **MENU** twice to open the Main Menu. Use the **Rocker** key to select the **Route** tab from the vertical menu of tabs.
2. Select the desired route and press **ENTER**. Press **MENU** to open the Route Review page options menu.
3. Highlight **Edit on Map** and press **ENTER**.
4. Use the **Rocker** key to select a location on the route (the route turns white when the arrow is over the route). Press **ENTER**.
5. Use the **Rocker** key to drag the route to the new point location and press **ENTER**.

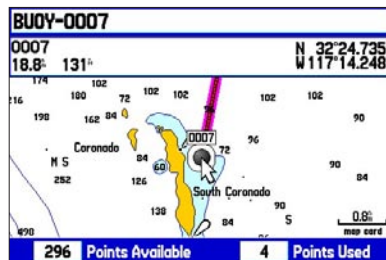

Editing the route on the map

6. If the New Waypoint page opens, edit the waypoint as desired, highlight **OK**, and press **ENTER**.
7. Repeat steps 4 through 6 until all desired points are added to the route. Press **Quit** when finished.

You can enter information about your trip so the GPSMAP 276C can estimate information about your trip, such as ETA and ETE.

To plan your route:

1. Open the Route Review page options menu.
2. Highlight **Plan Route** and press **ENTER**.

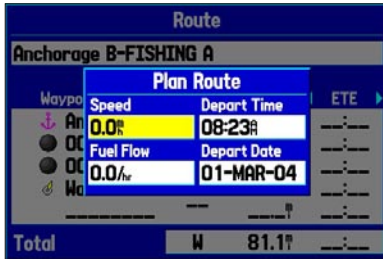

Entering Speed and Fuel Flow for trip planning

3. Enter the desired data for Speed and Fuel Flow. You also can enter the date and time of your departure. Press **QUIT** to return to the Route Review page.



NOTE: Fuel flow rates are measured in “units per hour.” System setting changes for units of measure (statute, nautical or metric) do not affect the fuel flow measure. You should enter fuel flow rates based upon information for your vehicle (such as the operator’s manual or performance specifications) and make note of the desired units of measure (gallons or liters).

Using the Route Tab Options

The Route tab in the Main Menu displays all the routes currently stored in memory, along with a descriptive name for each route. Highlight a route and press **MENU** to open the options menu. From here you can activate the route, copy it, delete it, delete all routes, and create a new route. You can also set up the routes to manually transition to the next waypoint.

Manually Transitioning to the Next Waypoint

From the Route tab Option Menu, highlight **Set Up Routes** and press **ENTER** to set the route leg transition (or waypoint transition). Select **Distance** to enter a radius so that when you are within the entered distance, the GPSMAP 276C will lead you to the next point on your route.

When you select **Manual**, you can transition to the next waypoint when you want while navigating a route. While you are navigating the route, open the Active Route page. Press **MENU**. Highlight **Next Route Waypoint** and press **ENTER** to have the GPSMAP 276C start routing you to the next point in your route.

Creating and Using Waypoints

Waypoints are locations or landmarks you record and store in your GPS. They are locations you may later want to return to, such as checkpoints on a route or significant ground features. You can add waypoints to routes and even create a Go To directly to the selected waypoint.

Save your current location as a waypoint by pressing and holding **ENTER/MARK**. You can also find waypoints using the map or the Find Menu and then store them in the unit before ever leaving home.

The GPSMAP 276C stores up to 3000 alphanumeric waypoints with a user-defined icon, comment, altitude, depth, and temperature available for each waypoint. Waypoints can be created using three basic methods:

- **ENTER/MARK**—allows you to quickly mark your present position.
- **Graphically**—allows you to define a new waypoint position from the map display using the **Rocker** key.
- **Text Entry**—allows you to enter a new waypoint's position coordinates manually.

Marking Your Present Position

The **ENTER/MARK** key lets you quickly capture your present position to create a new waypoint. You must have a valid position (2D or 3D) fix to mark your present position. You can determine the satellite fix by looking at the GPS tab on the Main Menu.

To mark your present position:

1. Press and hold the **ENTER/MARK** key until the New Waypoint page appears, then release it. A default four-digit name and symbol are assigned for the new waypoint.

New Waypoint		
Name	Category	
0001	Unfiled	
Comment		
09-NOV-04 11:06		
Elevation	Depth	Temperature
1061'	30.2'	62.7°F
Location		Modified
N 32°27.142'		09-NOV-04
W 117°16.792'		11:06:44"
Delete	Show Map	OK

New Waypoint Page

2. To accept the waypoint with the default information, use the **Rocker** key to highlight **OK** and press **ENTER**.

To change any information on the New Waypoint page, highlight the appropriate field and press **ENTER**. After entering and confirming your changes, highlight **OK** and press **ENTER**.

Creating Waypoints Using the Map

You can quickly create a waypoint using the Map page. When you pan the map and move the arrow over a map item, you will see a highlighted description of that item. The GPSMAP 276C uses the map item text shown on the map as the default name and symbol for the new waypoint.

To create a new waypoint using the Map page:

1. Press **PAGE** until the Map page is displayed.
2. Use the **Rocker** key to move the arrow to the desired map position or map feature.
3. Press and quickly release **ENTER/MARK** to capture the arrow position. Pressing and holding **ENTER/MARK** marks your present position, not the arrow's location.

If you have highlighted a map feature, an information page appears after you press **ENTER**. Use the **Rocker** key to highlight **Save** and press **ENTER** to save the item as a waypoint.

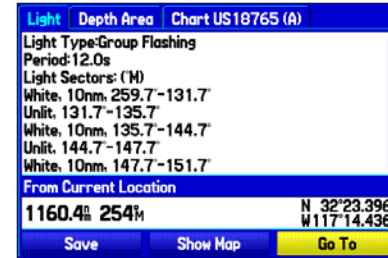

Map Feature Information Page

Select **Save** to save feature as a waypoint

4. The New Map Waypoint page appears. To accept the waypoint with the default information, highlight **OK** and press **ENTER**.

To change the any information on the New Map Waypoint page, highlight the appropriate field and press **ENTER**. After entering your changes, highlight **OK** and press **ENTER**.

Creating a Waypoint by Entering Coordinates

You can manually enter location coordinates to create a waypoint. This method can be useful for creating a waypoint at a specific latitude/longitude position from a chart. You can manually change the location coordinates in the New Waypoint page to create a new waypoint or use the **Create Waypoint** selection in the User Points tab options menu.

To create a new waypoint by entering location coordinates:

1. Press **ENTER/MARK** to create a waypoint (or use your favorite method discussed in previous sections). The new waypoint is created with the next available waypoint number and the receiver's last known position as the default position.
2. On the New Waypoint page, use the **Rocker** key to highlight the **Location** field and press **ENTER**. Use the **Rocker** key to enter the desired position coordinates and press **ENTER** when finished.

New Waypoint		
Name	Category	
0001	Unfiled	
Comment		
08-NOV-04 10:56		
Elevation	Depth	Temperature
Location		Modified
N 32°23.148'		08-NOV-04
W 117°14.693'		10:56:00
Delete	Show Map	OK

*To change the location of a waypoint, highlight the character you want to change in the **Location** field. Press Up or Down on the **Rocker** key to change the character. Repeat until the new location is entered.*

To change any of the other information on the New Waypoint page, highlight the appropriate field and press **ENTER**. After entering your changes, highlight **OK** and press **ENTER**.

Reviewing a Waypoint

Once you have created and stored a waypoint, you can modify, review, rename, move, or delete it at any time through the Waypoint Review and Waypoint Edit Pages. These pages provide virtually the same information. For practical purposes, we will refer to these pages as the “Waypoint pages,” unless it is necessary to discuss them individually.

To access the Waypoint Review page:

1. Use the **Rocker** key to highlight the desired waypoint on the Map page.
2. Press **ENTER** to display the Waypoint Review page. If the waypoint is located on a map feature or MapSource or BlueChart feature, the Waypoint Review page may include additional tabs containing information about the other features at that location.

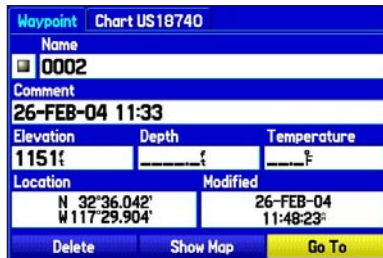

Waypoint Review Page

To access the Waypoint Edit page:

1. Press **MENU** twice to view the Main Menu.
2. Use the **Rocker** key to highlight **Points** from the vertical list of tabs, then highlight the desired waypoint from the list.



Points Tab in the Main Menu

3. Press **ENTER** to display the Waypoint Edit page.

If the waypoint is located on a map feature or MapSource or BlueChart feature, the Waypoint Edit page will NOT display the details of the other map features.

Use either of these methods to access the Waypoint page so you can edit the waypoint. Press **MENU** when the Waypoint page is open to access the Waypoint options menu.

Adding a Waypoint to a Route

Append to Route adds the selected waypoint to the end of a route. This option is displayed when you are not navigating. When you are navigating to a destination, **Add to Current Route** is displayed. The selected waypoint is added to the current route before the route destination.

To add a waypoint to the end of the route:

1. Open the Waypoint page and press **MENU** to open the options menu.

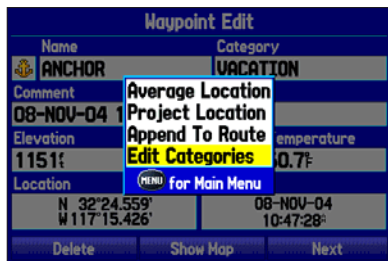

Waypoint Options Menu

2. Select **Append To Route** from the options menu. The Select Route window appears.
3. Highlight the desired route or select **New Route** and press **ENTER**.
4. With **OK** highlighted, press **ENTER** to save the waypoint.

Averaging the Waypoint's Location

Average Location makes the unit take several sample location measurements for the waypoint and recalculate for a more accurate position reading.

To calculate the average location:

1. Open the Waypoint page and press **MENU** to open the options menu.
2. Select **Average Location** from the menu and press **ENTER**.

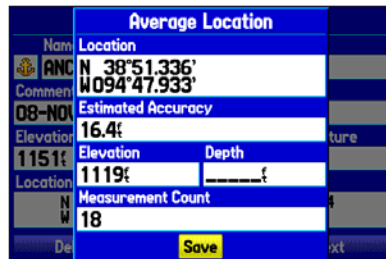

Average Location Page

3. The Average Location window appears. Watch the fields change as the unit calculates the average position of the waypoint. Press **ENTER** to save the position.



NOTE: You must have a GPS satellite fix before you can average a waypoint's location.

Projecting a Waypoint

You can also create a new waypoint by “projecting” the distance and bearing from a specific location to a new location.

To create a new waypoint by projecting its location:

1. Create a waypoint using your favorite method (discussed in previous sections). The new waypoint is created with the next available waypoint number and the receiver’s last known position as the default position.
2. Press **MENU** twice to open the Main Menu.
3. Highlight **Points** from the vertical list of tabs using the **Rocker** key.
4. Press **MENU** to open the New Waypoint page options menu.
5. Highlight **Project Location** and press **ENTER**.

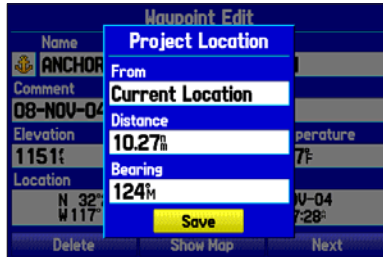

Project Location Menu

Enter the desired distance, bearing, and location to project from.

6. To change the location from which you are projecting the new waypoint, highlight the **From** field and press **ENTER**. The Find Menu opens.

Select the point that you will project your new waypoint from just as you would select a waypoint or point of interest. For more information see the “[Finding an Item](#)” section.

7. To adjust the distance that the new waypoint will be projected beyond the original waypoint, highlight the **Distance** field and press **ENTER**. Enter the projection distance and press **ENTER**.

To adjust the bearing that the new waypoint will be projected from the original waypoint, highlight the **Bearing** field and press **ENTER**. Enter the bearing and press **ENTER**.

8. When you have adjusted all elements of the projected location, highlight **Save** and press **ENTER**.
9. Make any other desired changes to the new waypoint data (such as the name or symbol), then highlight **OK** and press **ENTER**.

Editing a Waypoint

The User Points tab displays a master list of all waypoints currently stored in memory. From the User list, you may review, edit, rename, or delete individual waypoints or delete all user waypoints.

User	Proximity
ANCHOR	
0001	126M 11.7M
ANCHOR	124M 10.3M
GARMIN	052M 1164M
GRMEUR	022M 4772M
GRMTWN	295M 5985M
TOUR1	061M 2042M
TOUR2	061M 2042M

2990 Available 10 Used

User Points Tab

The total number of stored and available waypoints is displayed at the bottom of the User Points tab, with the stored waypoints arranged in numerical/alphabetical order.

To activate a Go To from the User Points tab:

1. Press **MENU** twice to open the Main Menu.
2. Select **Points** from the Main Menu, then highlight **User**.
3. Highlight the desired waypoint in the list.
4. Press **NAV** to open the Navigate Menu. Highlight **Go To <Point Name>** and press **ENTER**.

To edit the waypoint:

1. Open the Waypoint Review or Waypoint Edit page.
2. Highlight the waypoint name, symbol, or another field you want to change, and press **ENTER**.

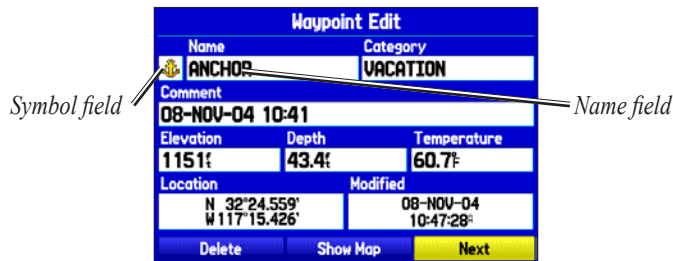

Waypoint Page

3. Use the **Rocker** key to select the desired symbol or enter data and press **ENTER** when done.

To edit the next waypoint in the list:

1. After you have edited the waypoint on the Waypoint Edit page (shown above), highlight **Next** and press **ENTER**.
2. The Waypoint list is displayed with the next waypoint highlighted. Press **ENTER** to edit that waypoint.

Organizing Waypoints into Categories

You can organize your waypoints into categories, which can help when managing and using your waypoints. For example, you can create a “Vacation” category that stores all of the waypoints you will use for your upcoming vacation. When the vacation is over, you can simply delete all the waypoints in that category by pushing a few buttons. You can create up to 15 categories.

To create a waypoint category:

1. From any of the waypoint pages or the Points Tab, press **MENU** to open the options menu.
2. Select **Edit Categories** and press **ENTER**.
3. Use the **Rocker** key to highlight **Add** and press **ENTER**.



Enter the name of the category, select **Save**, and press **ENTER**

4. Use the **Rocker** key to enter a name for the category.
5. Highlight **Save** and press **ENTER**.

Now, when you create or edit a waypoint, you can select the category from the **Category** list on the Waypoint page.

To assign a category to a waypoint:

1. Open the Waypoint page. (You can also change the category on the New Waypoint page.)
2. Select the **Category** field and press **ENTER**.



Waypoint Page

3. From the list, select the category you want to assign the waypoint to and press **ENTER**.

To delete a category:

1. With the Waypoint Categories window open, highlight the category to delete. Press **MENU**.

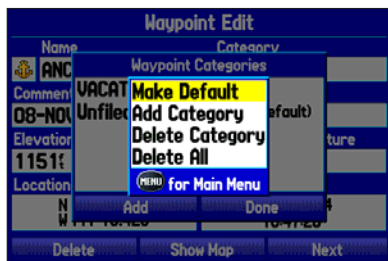

Waypoint Categories Options Menu

2. Select **Delete Category** and press **ENTER**.
3. Press **ENTER** again to finish deleting the category.

Deleting Waypoints

You can delete waypoints from the waypoint list in the Points tab or from the Waypoint pages. To delete a waypoint from the Waypoint page, use the **Rocker** key to highlight the on-screen **Delete** button and press **ENTER**.



NOTE: Once a waypoint is deleted from the list, it cannot be recovered from the unit. Back up important waypoints to a computer using the optional PC cable and interface software, such as MapSource, or write them down by hand.

To delete a waypoint from the User Points tab:

1. From the User Points tab, use the **Rocker** key to highlight the waypoint you want to delete.
2. Press **MENU**, highlight **Delete Waypoint**, and press **ENTER**.

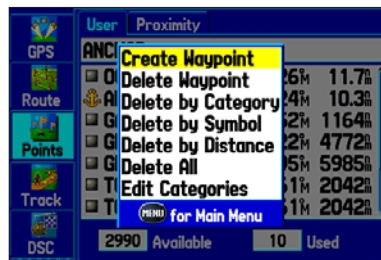

You can delete waypoints using a variety of methods. Press **MENU** to open the User Points options menu.

3. Press **ENTER** to confirm.

To delete waypoints by symbol or category:

1. From the User Points tab, highlight the waypoint you want to delete and press **MENU**.
2. Highlight **Delete by Symbol** or **Delete by Category** and press **ENTER**.

- When deleting by symbol, highlight the symbol of the waypoint you want to delete and press **ENTER**. When deleting by category, select the category you want to delete from the list and press **ENTER**.
- Highlight **OK** and press **ENTER** to confirm. Choose **Cancel** or press **QUIT** to exit without deleting.

To delete waypoints by distance:

- From the User Points tab, highlight the waypoint to be deleted and press **MENU**.
- Highlight **Delete By Distance** and press **ENTER**.
- Select **Less Than** or **More Than** and enter the desired distance using the **Rocker** key.
- If desired, you can select a waypoint or point of interest as the **From** location. Highlight the **From** field and press **ENTER**. From the Find Menu, select the desired location and press **ENTER**. When **OK** is highlighted, press **ENTER**.
- Highlight **Delete** and press **ENTER** to delete all waypoints within the set location. Choose **Cancel** or press **QUIT** to exit without deleting the waypoints.

Proximity Points

Use the Proximity Points tab to define an alarm circle around a stored waypoint position. The alarm circle can help you avoid reefs, rocks, or restricted waters. Up to ten waypoints may be listed with a maximum alarm radius of 99.99 nautical miles, statute miles, or kilometers.



Proximity Points Tab

If a proximity alarm circle overlaps an existing alarm circle, a “Proximity Overlaps Another Proximity Waypoint” message appears. Because the unit only alerts for one of the overlap points, use caution when navigating in these areas. If you enter an alarm circle overlap, you are only alerted to the closest proximity waypoint.

To turn proximity alarms on or off:

1. Press **MENU** twice to open the Main Menu.
2. Highlight **Points** from the vertical list of tabs. Highlight **Proximity** from the row of tabs along the top of the screen.
3. Use the **Rocker** key to highlight the field below **Proximity Alarm** and press **ENTER**.
4. Select the desired **On** or **Off** setting and press **ENTER**.

To add a proximity waypoint:

1. From the Proximity Points tab, use the **Rocker** key to highlight an empty line on the Proximity List and press **ENTER**. The Find Menu appears.
2. Select the desired waypoint or point of interest from the Find Menu. With **OK** highlighted, press **ENTER** to select that point. (For complete information about selecting waypoints or points of interest from the Find Menu, see “[Finding an Item](#)” on page 18).
3. The distance field is now highlighted. Press **ENTER** to begin entering the proximity radius.
4. Use the **Rocker** key to enter a distance value (up to 99.99 units) and press **ENTER**.

To clear one or all proximity waypoints from the list:

1. Press **MENU** twice to open the Main Menu.
2. Highlight **Points** from the vertical list of tabs. Highlight **Proximity** from the row of tabs along the top of the screen.
3. Use the **Rocker** key to highlight the proximity waypoint to clear and press **MENU**.

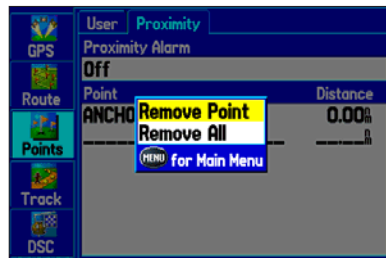
**Proximity Points Tab Options Menu**

4. To clear a single alarm, highlight **Remove Point** and press **ENTER**. To clear all proximity waypoints, select **Remove All** and press **ENTER**.
5. Use the **Rocker** key to highlight **OK** and press **ENTER** to confirm.

Managing Your Tracks

The GPSMAP 276C draws an electronic breadcrumb trail or “track log” on the Map page as you travel. The track log contains points along its path, including time, and position for each point.

The track log starts recording as soon as the GPSMAP 276C gets a location fix. For the best results, clear the track log before you start traveling because when the track log is full, new track points overwrite the oldest track points.

The percentage of memory used by the current track log appears at the top of the Active tab. After the track log is cleared, it displays zero percent. When the display reaches 100%, the most recent track points start to overwrite the least recent track points (if **Wrap** is selected for **Record Mode**). To avoid losing track points, save the track log when it approaches the 99% mark.

You must first save the track log before you can use the **Navigate Track** feature. The **Save** feature allows you to store up to 15 track logs from certain times and dates.

To access the Track tab:

1. Press **Menu** twice to open the Main Menu.
2. Highlight **Track** from the vertical list of tabs.

Setting up and Saving your Tracks

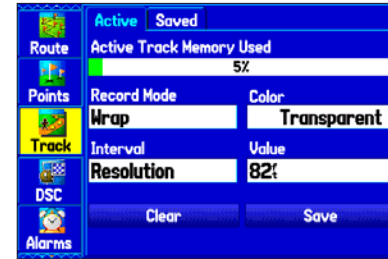

Active Track Tab

Record Mode—Wrap records over the oldest tracks when the track log reaches 100%. **Fill** records a track log until the track log is full (100%). When **Off** is selected, the unit does not record tracks.

Interval—Distance records track points after a specified distance has been traveled. **Time** creates track points after a specified time has elapsed. **Resolution** records track points based upon the resolution. The higher the resolution entered, the more points the unit creates to make the track.

Value—records a track according to the **Interval** and **Value**. Enter a specific distance, time, or resolution.

Color—select a color for the track when it is displayed on the map.

To clear the track log:

1. Press **MENU** twice to display the Main Menu.
2. Highlight **Track**, then highlight the **Active** tab to the right.
3. Select the **Clear** button and press **ENTER**.

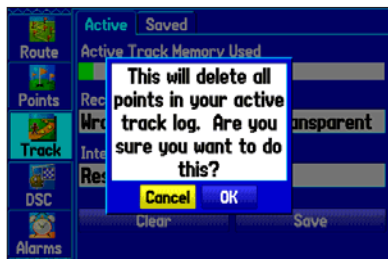

Clearing the track log

4. Highlight **OK** and press **ENTER**. Press **QUIT** to exit.

To save the entire track log:

1. Press **MENU** twice to open the Main Menu.
2. Highlight **Track**, then highlight the **Active** tab to the right.
3. Use the **Rocker** key to select **Save** and press **ENTER**.
4. A window pops up asking if you want to save the entire track log. To save the entire track, highlight **Yes** and press **ENTER**.

To save a portion of the track log:

1. Press **MENU** twice to open the Main Menu.
2. Highlight the **Track** tab, then highlight the **Active** tab.
3. Use the **Rocker** key to select **Save** and press **ENTER**.
4. To save only a portion of the track, highlight **No** and press **ENTER** when the pop-up window appears.
5. Select a beginning point and press **ENTER**. Select an ending point and press **ENTER**.

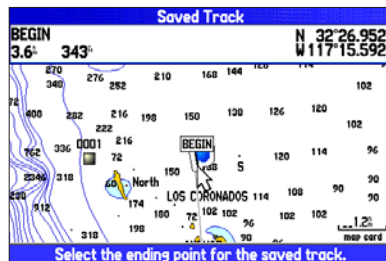

Saving a portion of the track log

6. The Track Review page automatically opens. Highlight **OK** and press **ENTER** to save the track. Press **QUIT** to exit.

Saved Tracks

The Saved tab lists all of the saved tracks in your unit.



Saved Tab

Press **MENU** to open the Saved tab options menu:

Review on Map—displays the highlighted track on the Map page.

TracBack—navigates the track. You can either navigate the track as it is saved, or you can navigate the track in reverse.

Delete Track—erases the highlighted track from the unit's memory.

Delete All—erases all tracks from the unit's memory.

To edit a track:

1. Press **MENU** twice to open the Main Menu.
2. Highlight the **Track** tab. Press the **Rocker** key right to highlight the **Saved** tab.

3. Highlight the track you want to edit and press **ENTER**. The Track Review page opens. Make changes as desired.

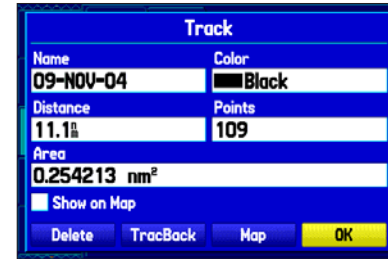

Track Review Page

4. Highlight the **Name** field and press **ENTER**. Use the **Rocker** key to change the name and press **ENTER**.
5. Select a different display color when the track is displayed on the map.
6. To display this track on the map, highlight the box next to **Show on Map** and press **ENTER**.
7. To begin a TracBack, highlight **TracBack** and press **ENTER**. For more information about the TracBack feature, refer to the next page.
8. To view the track on the map, highlight **Map** and press **ENTER**. Press **QUIT** to return to the Track tab.
9. Highlight **OK** and press **ENTER** to save the track. Press **QUIT** to exit.

Navigating a Saved Track

You can save your track log to use later as a TracBack, which reduces your track log into a route with up to 300 turns. Once activated, a TracBack route leads you back to the oldest stored track log point. It is a good idea to clear the existing track log before you start your current trip. Also, you must save an active track log before you can navigate it as a TracBack.

To activate a TracBack using the NAV key:

1. Press **NAV**, highlight **Navigate Track**, and press **ENTER**.
2. Highlight the track you want to navigate and press **ENTER**.

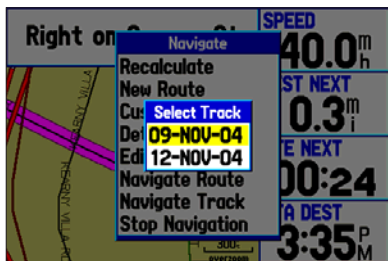

Selecting a Saved Track

3. Use the **Rocker** key to select the point you want to navigate to (TracBack to) and press **ENTER**.

TracBack Tips

Once a TracBack has been activated, the GPSMAP 276C divides the track into segments called legs. Up to 300 temporary turns are created to mark the most significant features of the track in order to duplicate your exact path as closely as possible. To get the most out of the TracBack feature, remember these tips:

- Always clear the track log at the point that you want to go back to (such as a dock or campsite).
- The **Record Mode** option on the Active Track tab must be set to **Fill** or **Wrap**.
- If the track log **Interval** option on the Active tab is set to the **Time** option, the route may not navigate your exact path (keep the interval set to Resolution for best performance).
- If the receiver is turned off or satellite coverage is lost during your trip, TracBack draws a straight line between any point where coverage was lost and where it resumed.
- If the changes in distance and direction of your track are too complex, 300 waypoints may not mark your path accurately. The receiver then uses the most significant points of your track so there will be fewer changes in direction.

Following a Marine Route

After you activate a route, the GPSMAP 276C automatically starts guiding you to the destination using a variety of tools and pages.

See Your Route on the Map Page

You can track the progress of your route on the Map page. Your route is shown with a magenta line. For more information see the “Map Page” section beginning on page 43.

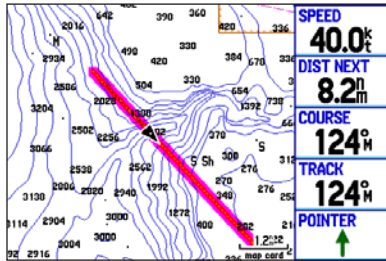

Map Page

View Your Heading with the Compass Page

During active navigation, the Compass page guides you to your destination with digital data fields and a graphic compass display with a bearing pointer. When the pointer is pointing straight up, you are heading directly to your destination. For more information see “Compass Page” beginning on page 48.

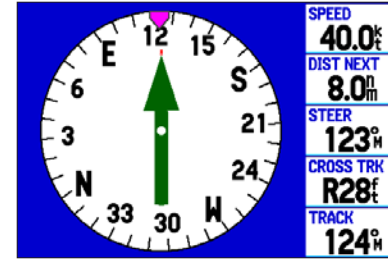

Compass Page

View Your Path on the Highway Page

Whenever a route has been activated, the Highway page provides digital and graphic steering guidance to the destination. A compass ribbon is displayed at the top of the page to show your current heading, represented by the violet bar. The red vertical bar represents the bearing to your course. To stay on course, steer towards the red vertical indicator (or arrows) until it lines up with the violet bar in the middle. The bottom section of the screen provides visual guidance to the waypoint on a graphic highway display. The line down the center of the highway represents your desired track line.

For more information see “Highway Page” beginning on page 50.

See Your Progress on the Active Route Page

Whenever you have activated a route in Marine Mode, the Active Route page shows each point (waypoint or map item) of the active route, as well as the point name, Course, Distance, and several other fields of information. The active point is marked with an arrow icon. As you navigate a route, the list automatically updates to indicate the next active point.

For more information see the “Active Route Page” section beginning on page 52.

Active Goto			
Waypoint	Course	Distance	ETA
→ ANCHOR	---	7.7 ^M	11:23 ^A
Total			
	---	7.7 ^M	11:23 ^A

Active Goto (Route) Page

Watch Your Trip Data on the Position Data Page

The Position Data page provides a quick view of the important data you want to see while navigating a route in Marine Mode. The compass ribbon is displayed at the top of the page to show your current heading with a red, vertical bar. To stay on course, steer towards the violet bar (or arrows) until it is aligned with the red bar.

For more information see the “Position Data Page” section beginning on page 53.

105 120 SE 1	NEXT WPT ANCHOR	ETE NEXT 10:15
N 32°30.024'	TTL AVG SPD 0.0 ^K	MAX SPEED 4.8 ^K
W 117°21.487'	TRIP ODOM 219 ^F	MOVE TIMER 00:23
11:13:42 ^A 08-NOV-04	SUNRISE 8:12 ^A	SUNSET 6:53 ^P
From ANCHOR:	BATTERY	POWER
7.5 ^M 304 ^M		



Position Data Page

MARINE MODE PAGES AND FEATURES

This section discusses the major pages in Marine Mode, such as the Map and Compass pages, as well as some additional marine features, such as DSC and the marine timer.

Map Page

The GPSMAP 276C features a real-time moving map that can do much more than just plot your course. The Map page displays map information (digital cartography) that includes nav aids, lakes, rivers, coastlines, cities, and highways. Use the dedicated zoom keys (**IN** and **OUT**) to adjust the Map page scale.

Two basic map operating modes, position mode and pan mode, determine what cartography is shown on the map display. Position mode pans the map to keep your present position in the display area. The position marker  shows your travel on the Map page. The GPSMAP 276C always powers up in position mode, with the last known location centered on the map. When you press the **Rocker** key, the GPSMAP 276C enters pan mode, which moves the map to keep the white arrow  (map pointer) within the display area.

In Marine Mode, by default, four user-selectable data fields appear on the right side of the screen that can be configured to display any one of the possible data options. You can also add additional data fields to the page or select a full screen map without data fields.

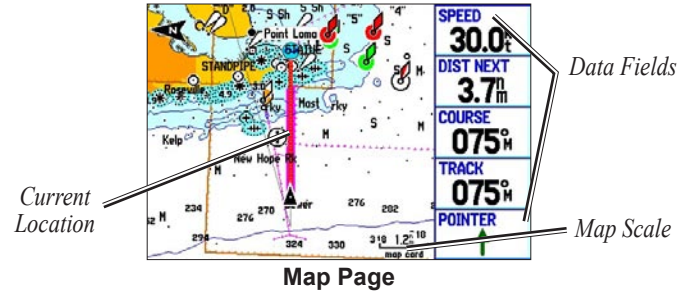

Map Orientation

There are two map orientation options: North Up orients the map like a paper map, while Track Up orients the map in the direction of travel. When using Track Up, the North arrow indicates the orientation. To change the map orientation, press **MENU** to open the Map page. Press **MENU** again. Select **Set Up Map** and press **ENTER**. Refer to page 78 for information.

Zooming In and Out of the Map

The map display has 28 available zoom scales ranging from 20 ft to 800 nm (20 ft to 800 mi or 5 m to 1200 km). The map scale is controlled by the **IN** and **OUT** keys, with the current scale displayed at the bottom right of the data window.



NOTE: The scale value represents the distance from one end of the scale bar () to the other.

To select a map scale (zoom in and out):

- Press the **OUT** key to zoom out.
- Press the **IN** key to zoom in.

The system has a built-in worldwide database, with more detailed coverage available through the use of the BlueChart or MapSource data. The GPSMAP 276C displays cartography as long as there is chart information available for the zoom scale you have selected.

Map coverage conforms to the following conditions:

- Cartography is displayed when the selected zoom scale is covered by either the internal basemap or other MapSource data loaded onto a data card.
- When the selected zoom scale is covered by both the internal database and data card map information, the cartography with the best resolution is displayed.
- When the selected zoom scale exceeds the resolution of the data in use, “overzoom” appears below the map scale.



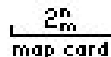

No additional data is available

- When external data (such as MapSource data) is used, “map card” appears below the map scale.



Using detailed maps loaded on the data card

Panning the Map

The panning arrow  allows you to pan the map to view other map areas. As you pan past the edge of the current map display, the screen moves to provide continuous map coverage. The position icon  stays in your present location and may not be visible on the display screen when you pan the map.

To pan the map:

Press Up, Down, Right, or Left on the **Rocker** key.

The panning arrow moves the map so you can view different parts of the map.

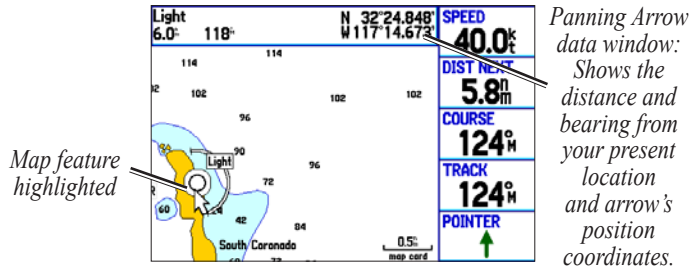

Panning the Map

As you move the arrow, the distance and bearing from your present position to the arrow appears in the data window, along with the arrow's position coordinates. When you zoom in pan mode, the arrow stays centered on the screen. When the arrow is stationary, fixed coordinates appear in the position field, and the distance and bearing from your present position update as you move.

To re-center your position on the screen:

When you are finished panning the Map, press **QUIT**.

The map automatically moves to show your present location, and the unit returns to position mode.

The arrow may also be used to select on-screen map items, allowing you to review a selected item directly from the map display.

To view details about an on-screen point:

1. Use the **Rocker** key to move the arrow to the desired waypoint or map item. If there are several items grouped closely together, zoom in closer for a better view.

When a waypoint or map item is selected, it is highlighted on screen with the name and position displayed at the top of the screen, along with the distance and bearing from your current location, as shown in the image to the left.

2. Press **ENTER** to view more information about the point. The information and on-screen buttons displayed vary depending on the type of item selected. In some cases, additional information tabs appear at the top of the Information page or Waypoint page.
3. If desired, use the **Rocker** key to highlight the extra tabs and view the information.
4. Select an on-screen button and press **ENTER**. Press **QUIT** to exit the information page.

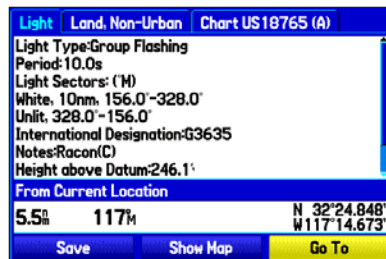

Map Feature Information Page

Clearing Unwanted Details from the Map

You can remove items from the Map page display (declutter the display) to remove unwanted items, such as highways. To quickly declutter the map, press **ENTER**.

To declutter the Map page:

1. From the Map page, press **MENU** to open the options menu.
2. Use the **Rocker** key to highlight **Declutter** and press **ENTER**.
3. Press **ENTER** again to return the detail to the map display.

You can also press **MENU**, highlight **Declutter On/Declutter Off**, and press **ENTER**.

Measuring Distance

You can measure the distance and bearing between two map items.

To measure the bearing/distance between two points:

1. From the Map page, press **MENU** to open the options menu.
2. Highlight **Measure Distance** and press **ENTER**. An on-screen arrow appears on the map display at your present position with **ENT REF** below it.
3. Move the arrow to the desired reference point (the starting point that you want to measure from) and press **ENTER**. A push-pin icon marks the starting point on the map display.
4. Move the arrow to the point want to measure to. The bearing and distance from the reference point and arrow coordinates are displayed in the data window at the top of the display.
5. Press **QUIT** to finish.

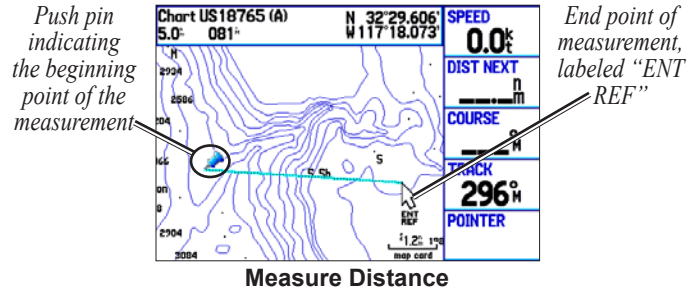

Compass Page

During active navigation, the Compass page guides you to your destination with a graphic compass display and a bearing pointer. Press **PAGE** repeatedly to display the Compass page.

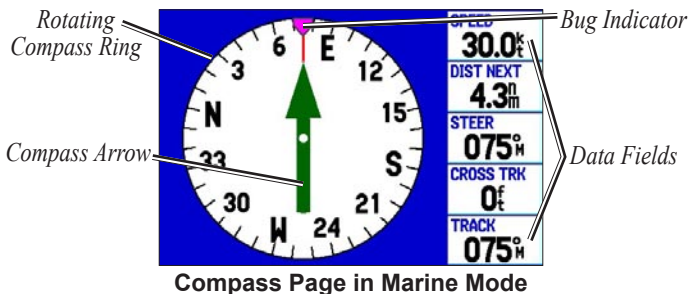

The middle of the page features a rotating “compass ring” that shows your course over ground (track) while you are moving. Your present course over ground is indicated at the top of the compass ring. The direction of the destination (bearing) relative to the course over ground is indicated by an arrow in the middle of the compass ring and a bearing “bug” on the outside of the compass ring.

If the arrow points up, you are going directly to the waypoint. If the arrow points any direction other than up, turn toward the arrow until it points up, then continue in that direction.



NOTE: You must be moving for the compass to accurately update and display your heading.

Turning On the Compass Page

The Compass page is on by default in Marine Mode but off by default in Automotive Mode.

To show the Compass page in Automotive Mode:

1. Press **MENU** twice to display the Main Menu.
2. Use the **Rocker** key to highlight the **Display** tab.
3. Highlight the **Compass page** field and press **ENTER**. Select **On** and press **ENTER**.

Compass Page Options

The options menu on the Compass page allows you to customize the Compass page to your preferences. Like the Map page, the Compass page features user-selectable data fields. For definitions of data field options, refer to page 116. When the Compass page is open, press **MENU** to open the options menu.

Show Course Pointer—displays the Course Pointer that shows how to get back on course.

Show Bug Indicator—displays the bearing bug indicator (the purple tick mark on the compass ring).

Using the Marine Timer

The Marine Timer, specifically designed for sail boat racing, allows you to easily count up or down by specified time increments. As is common in sail boat racing, there is often a 5-minute warning countdown, followed by a 4-minute preparation countdown, and finally a one-minute final countdown. Then during the race, mariners may want to count up to keep track of their time. By default, all of these different count downs and count ups can easily be performed with the GPSMAP 276C by pressing a few buttons.

You must change the Compass page layout to use the Marine Timer.

To open the Marine Timer:

1. Press **PAGE** repeatedly until the Compass page is displayed.
2. Press **MENU**.
3. Use the **Rocker** key to highlight **Set Up Page Layout** and press **ENTER**.
4. Highlight **2 Columns With Timer** and press **ENTER**. The Marine Timer is displayed in the lower right corner.

To use the Marine Timer:

1. Press the **Rocker** key Up or Down to select the time you want to count. Five (5) minutes is the default.
2. Press **ENTER** to start the timer. Use the **Rocker** key during the timing to quickly select a different length of time.
3. Press **ENTER** to stop timing.



Marine Timer on the Compass Page

As discussed previously, the timer is set to count down five minutes. If you want to change the length of time and the behavior or the timer, open the Timers Setup tab in the Main Menu.

To set the Marine Timer:

1. Press **MENU** twice to open the Main Menu.
2. Press the **Rocker** key down to select **Setup** and then left to select the **Timers** tab.
3. Highlight **Stop** next to **Marine** to change the timer's behavior.
4. Highlight the time field, press **ENTER**, and then use the **rocker** key to enter a new time.

Highway Page

The Highway page is available in both Marine Mode and Automotive Mode, though it is not displayed by default in Automotive Mode. See the directions to the right to display the Highway page. Press **PAGE** repeatedly to open the Highway page.

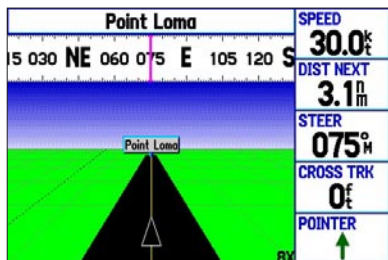

Highway Page

When you are navigating, the Highway page provides digital and graphic steering guidance to the destination. The right side of the Highway page features user-selectable data fields displaying useful navigation information. A compass ribbon is displayed at the top of the page to show your current heading. The violet bar and the red vertical bar on the compass ribbon indicates the bearing to your course.

To hide/show the Highway page:

1. Press **MENU** twice to display the Main Menu.
2. Use the **Rocker** key to highlight the **Display** tab.
3. Highlight the **Highway page** field and press **ENTER**.
4. Select **Off** to hide or **On** to show and press **ENTER**.

Using the Highway Page

To stay on course, steer towards the violet bar (or arrows) until it lines up with the red bar in the middle. The bottom section of the screen provides visual guidance to the waypoint on a graphic highway display. The line down the center of the highway represents your desired track line.

As you head toward your destination, the highway perspective moves to indicate your progress to the waypoint and which direction you should steer to stay on course. If you are navigating a route, the Highway page shows each route waypoint in sequence connected by a black “road” with a white line down the middle, which is your desired track line. Nearby waypoints not in the active route can also be displayed. You can zoom in or out to display a larger or smaller view of the highway.

To change the highway perspective scale:

- Press **IN** to zoom in.
- Press **OUT** to zoom out.

Highway Page Options

The Highway page options menu allows you to define the data fields and select which waypoints and track are displayed on the screen. The data fields, located along the right side of the page, provide a user-selectable layout of various types of useful data. The layout may also be changed to display additional data fields.

To display and select the Highway page Options:

1. Press **PAGE** repeatedly until the Highway page is displayed.
2. Press **MENU**.
3. Use the **Rocker** key to highlight the desired option.
4. Press **ENTER**.

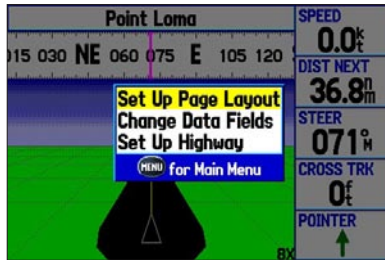

Highway Page Options Menu

The following options are available from the Highway page menu:

Set Up Page Layout—allows you to choose the number of data fields that appear on the Highway page.

Change Data Fields—allows you to specify the type of data displayed in each data field on the Highway page. This option is available from any of the main pages. See page 116 of the “Appendix” for a listing of the data fields.

Set Up Highway—displays an options menu with two tabs: Line and Waypoint. Each tab has On/Off settings for several options, such as enabling the line for the Active Leg and Track Log.



Set Up Highway

Active Route Page

Whenever you have activated a route in the GPSMAP 276C, the Active Route Page shows each point (waypoint or map item) of the active route, with the point name, Course, Distance, and several other fields of information. The current destination point, the active point, is marked with an arrow icon. As you navigate a route, the list automatically updates to indicate the next active point. The Active Route and Route Review Pages share many of the same features and options.

Press **PAGE** repeatedly to display the Active Route page.

Active Route			
Anchorage B-Waverider			
Waypoint	Course	Distance	ETA
↓ Anchorage	SW	---	---:--A
● 0001	S	19.4 ^M	10:13 ^A
→ ● 0002	W	31.9 ^M	10:32 ^A
⚡ Waverider	---	---	---:--A
Total	SW	31.9^M	10:32^A

Active Route Page

Active Route Page Options

The following route options are available by pressing **MENU**:

Active Route	
Anchorage B	Deactivate
Waypoint	Edit on Map
	Add Waypoint
↓ Ancho	Remove Waypoint
● 0001	Invert
→ ● 0002	Plan Route
⚡ Waver	Change Data Fields
	MENU for Main Menu
Total	SW 32.1^M 10:33^A

Active Route Page Options Menu

Deactivate—stops route navigation.

Edit on Map—allows you to edit the route on the map. See page 24.

Add Waypoint—inserts a point before the highlighted waypoint or add a point(s) to the end of the route.

Remove Waypoint—deletes the selected waypoint from the route.

Invert—reverses the order of the route.

Plan Route—allows you to enter information about your route to more accurately provide you with arrival times.

Change Data Fields—allows you to customize the data fields displayed on the Active Route Page.

Position Data Page

The Position Data page displays important navigation data while navigating a route in Marine Mode. By default, the page displays a compass ribbon, your current latitude and longitude, the current date and time, the location you are traveling from, and eight user-selectable data fields. The compass ribbon is displayed at the top of the page to show your current heading with a red, vertical bar. To stay on course, steer towards the violet bar (or arrows) until it is aligned with the red bar.

Press **PAGE** repeatedly to open the Position Data page.

Waypoint is selected as the Nearest Type. Coronado, CA is the nearest waypoint.

060 075 E	NEXT WPT Point Loma	ETE NEXT 05:21
N 32°39.969' W 117°17.117'	TTL AUG SPD 0.0k	MAX SPEED 1.0k
09:59:41 ^A 26-FEB-04	TRIP ODOM 19.6k	MOVE TIMER 00:18
From Coronado, CA:	SUNRISE 08:21 ^A	SUNSET 07:42 ^P
5.6k 246k	BATTERY	POWER

Position Data Page

Position Data Page Options

With the Position Data page open, press **MENU** to open the options menu. You can set up the layout of the page and change the data fields. For an explanation of the data fields, refer to page 116 in the *GPSMAP 276C Owner's Manual*

“Appendix.” You can also select one of the following options:

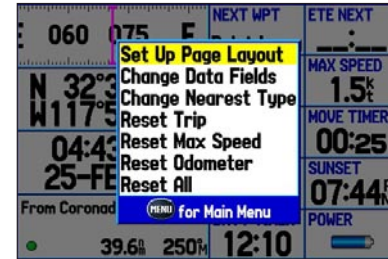

Position Data Page Options Menu

Change Nearest Type—allows you to specify the type of item to be used as the nearest item (displayed in the lower-left data field). The choices change based upon the Usage Mode you are currently using.

Reset Trip—clears trip information, except the maximum speed and the odometer.

Reset Max Speed—clears the maximum speed.

Reset Odometer—clears the running total of the distance traveled since the odometer was last reset.

Reset All—clears all trip information including the maximum speed and odometer.

DSC

The DSC page of the Main Menu (Marine Mode only) allows you to control and set up the Digital Selective Calling (DSC) features on the GPSMAP 276C. Digital Selective Calling (DSC) uses marine VHF radio and Global Positioning System (GPS) technologies to transmit and receive location information. DSC is used by mariners for two major operations: Distress Calls and Position Reporting.

For more information about Digital Selective Calling and Maritime Mobile Service Identity (MMSI) numbers, refer to pages 113–114 in the “Appendix.”



DSC Page

Understanding Distress Calls

With your GPSMAP 276C properly connected to a VHF radio with DSC output, you may receive any DSC Distress Call within range. An alert message appears and a tone sounds when a Distress Call is received. The alarm only sounds on a Distress Call; Position Reports do not sound the alarm. Distress Calls are broadcast to all DSC users in radio range and appear with a blue and white checkered icon on the DSC Call List and Log tabs.

You can enter a caller’s name, if it is known. The caller’s name replaces the MMSI number as a reference once entered.

Understanding Position Reports

The Position Report operates similarly to the Distress Call. This type of contact is like a phone call; no emergency alarms are set off. Position Reports are not broadcast to all DSC users and appear with a gold boat icon.

Receiving DSC Calls

Each time you receive a Distress Call or Position Report, a review page opens—either a DSC Position Report page or a Distress Call page. Both pages contain identical fields to the DSC Entry Review page shown below.

Each entry in the Call List and Log has a corresponding DSC Entry Review page. This page operates similarly to the Distress Page and Position Report Page. From the DSC Entry Review, you can **Delete** the entry, **Save** it as a waypoint, or show the location on the map.

To review a call or log entry:

1. Open the Call List or Log from the **DSC** tab.
2. Press Up or Down on the **Rocker** keypad to highlight the call you want to review.
3. Press **ENTER** to open the DSC Entry Review page.

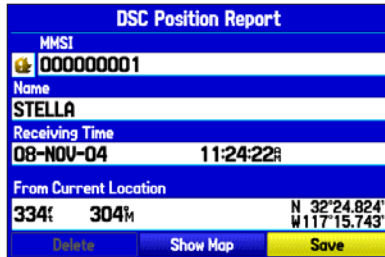

DSC Entry Review Page

DSC Call List

The Call List displays the 50 most recent calls, even if the unit is left unattended. The Call List only displays the most recent call from a vessel. If a second call is received, it replaces the first call in the Call List. Press **MENU** to sort the list and delete entries.

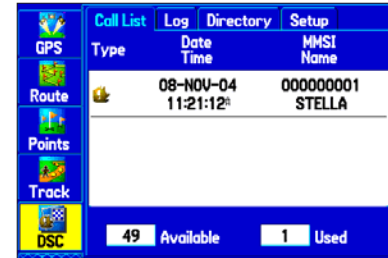

DSC Call List

DSC Log

When DSC calls are received, they are automatically stored in the Log, with the latest call at the top. The unit may store up to 100 calls; after 100 calls are received, the oldest log file is removed when a new call is received. Press **MENU** to sort the list and delete entries.



DSC Log

Receiving a Position Report or Distress Call

After you have received a Position Report or a Distress Call, you can quickly navigate to the location. Highlight the desired call from the **Call List** or **Log** and press **Direct To**. The top selection in the Navigate Menu is highlighted. Press **ENTER** to go to the location.

DSC Directory

The DSC Directory acts much like a phone book and can hold up to 50 entries. Pressing **MENU** from this page allows you to add a **New Item**, **Delete** a highlighted entry, or **Delete All** entries.

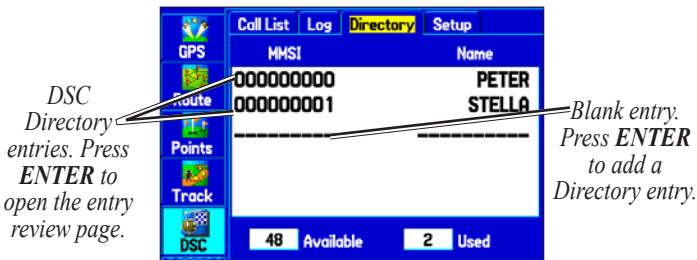

DSC Directory list

To add a new Directory entry:

1. Open the DSC Directory in the Main Menu.
2. Use the **Rocker** key to highlight the first blank space in the directory list and press **ENTER**.
Or, press **MENU**, highlight **New Item**, and press **ENTER**.
3. Enter the MMSI number, the Name, and any comments.
4. When finished, highlight **OK** and press **ENTER**.



After creating a New Directory Item, the name created is attached to that particular MMSI number. If you return to the Log, the new name is displayed under the corresponding MMSI number.

Another way to input a name is from the Entry Review page or the DSC Distress Call or DSC Position Report pages. The Name and MMSI are sent to other Garmin GPS units: Only the MMSI numbers are sent to other non-Garmin DSC users.

Making a Distress Call

To make a Distress Call, press the MayDay button on your VHF radio. The call transmits on an emergency channel with the MMSI number attached to the call, if you have DSC support. Any DSC-equipped mariner (on sea or land) within range can receive the call.

Setting up DSC

The DSC Setup tab allows you to turn DSC On and Off. If you have more than one chartplotter and only want DSC to display on another chartplotter, turn DSC off on this unit.

This Setup tab also allows you to simulate Distress Calls and Position Reports while the unit is in Simulator mode (see page 11). Simulating calls is helpful for practice before connecting to the real system. The Distress Call simulator also helps to check if alarms are working properly.

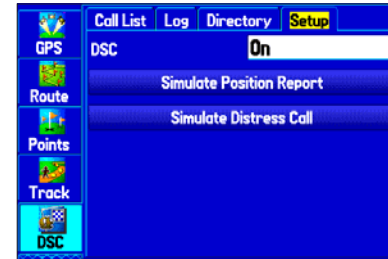

DSC Setup

BASIC OPERATION IN AUTOMOTIVE MODE

This section discusses some of the more common Automotive operations you will perform with your GPSMAP 276C in Automotive Mode. Please note that many common operations, such as marking a waypoint and creating a route, are performed the same way as in Marine Mode. Refer to the Marine Mode sections for operations and information not found in this section.

Automotive Mode Page Sequence

Automotive Mode features two main pages: the Map and Trip Computer pages. Optional Highway and Compass pages may be enabled in Automotive Mode. Two additional pages appear during active navigation while in Automotive Mode—a Current Route page appears if you are navigating a turn-by-turn route and an Active Route page appears if you are navigating “Off Road.” See “Navigating in Automotive Mode” on the next page for more information.



To switch usage modes:

1. Press and hold the **PAGE** button.
2. Use the **Rocker** key to select either **Automotive** or **Marine** and press **ENTER**.

Navigating in Automotive Mode

When you initiate navigation in Automotive Mode, the GPSMAP 276C automatically generates a turn-by-turn route. In some instances, you may need to select the Follow Roads option to generate a turn-by-turn route.

Once you are actively navigating, you will see a magenta line that always runs from your current location to your destination on the Map page. You can use the Map page, Compass page, Highway page, and Position Data page to help navigate to your destination.

Initiating Navigation

There are several ways to begin navigating to a point:

- Select a point on the map and press the **NAV** key.
- Press the **NAV** key to activate a new route using the Find Menu, or activate a saved route or track.
- Press the **FIND** key to search for a particular item and create a route to it.

To go to a highlighted map item:

1. Use the **Rocker** key to highlight the item you would like to navigate to on the Map page.
2. Press **NAV**. **Go To <point name>** is added to the list of options and automatically highlighted. If you have selected an area of the map that is not a map feature **Go To MAP Point** is listed. Select **Go To <point name>** or **Go To MAP Point** and press **ENTER**.

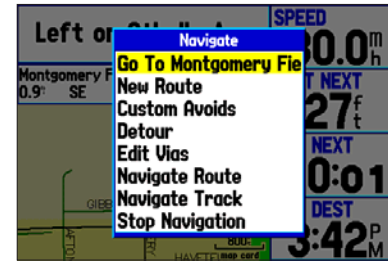

Navigate Menu

with Map Feature highlighted

3. Follow the magenta route created on the Map page. Follow the turn-by-turn route (auto-route) by using the Next Turns page and Current Route page. If you are using the external speaker, follow the voice prompts.

To create a new route:

1. Press the **NAV** key to open the Navigate Menu.
2. Highlight **New Route** and press **ENTER**.
3. From the Find Menu, highlight **Waypoints** and press **ENTER**. (You may also choose to go to other points, such as **Cities** or **Tide Stations** from this list. The steps vary only slightly from those listed for Waypoints.)
4. Select a waypoint from the list and press **ENTER** to display the Waypoint page.

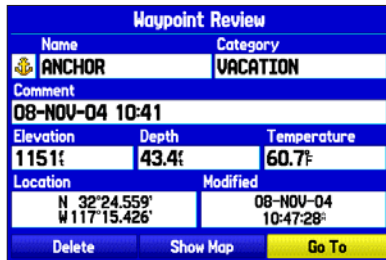

Waypoint Review Page

Activating a Go To using the Find Menu

5. The Waypoint page automatically opens. With the **Go To** button highlighted, press **ENTER** to begin navigation.

To go to a destination using the Find Menu:

1. Press **FIND** to open the Find Menu.
2. Using the **Rocker** key, highlight the desired category, such as **Cities**, and press **ENTER**.
3. Press **ENTER** and use the **Rocker** key to begin entering the letters contained in the item name. The list begins to sort by the items which contain the letters you are entering. Press **ENTER** when finished.



Finding an item using the Containing field: The unit searches for items containing the letter combination you enter and displays them in the list.

3. Highlight the desired item from the list and press **ENTER**.
4. Press **ENTER** when the **Go To** button is highlighted.

For complete information about finding an item, refer to the [“Finding an Item”](#) section on page 18.

Following a Saved Route

The Navigate Menu also allows you to follow a saved track or route. If you want to follow roads on your route, be sure that you press **MENU** and select **Follow Roads** on the Active Route page.

To follow a saved route in Automotive Mode:

1. Press the **NAV** key to open the Navigate Menu.
2. Highlight **Navigate Route** and press **ENTER**.
3. Highlight the route you want to activate and press **ENTER**.
4. The Active Route page automatically opens with the route activated. Press **MENU** to open the options menu.
5. Highlight **Follow Roads** and press **ENTER** to create a turn-by-turn route (auto-route), which is displayed in the Current Route page.

You can also activate a Saved Route from the Saved Route tab in the Main Menu.

Stopping and Resuming Navigation

At any time when you are navigating to a point, you can stop navigation. For example, if you are on a long car trip, but you want to stop for dinner, you can stop navigation and resume after dinner.

To stop navigation:

1. While navigating to a point, press the **NAV** key.

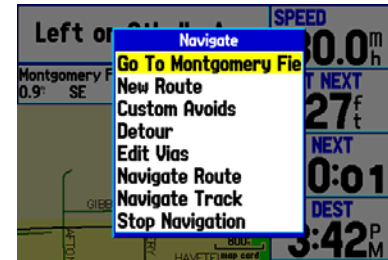

Navigate Menu in Automotive Mode

2. Use the **Rocker** key to highlight **Stop Navigation** and press **ENTER**.

To resume navigation:

1. After you have stopped navigation, press the **NAV** key.
2. Use the **Rocker** key to highlight **Resume Navigation** and press **ENTER**.

Editing Your Route

Once you are navigating a route, you can edit that route. You can add areas and roads to avoid as well as temporary detours to your current route. You can also add stops along your trip, called via points.

While navigating, press the **NAV** key to open the Navigate Menu, shown below.

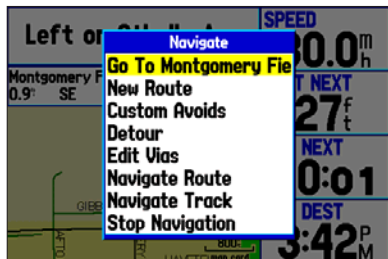

Navigate Menu in Automotive Mode

While navigating a course

Entering Custom Avoids

Custom Avoids allows you to enter specific areas and roads that you would like to avoid in your navigation. Custom Avoids apply to all routes, but Detours apply to only the active route. Custom Avoids can be added while you are navigating a route or before you navigate.

To enter a custom avoid:

1. Press the **NAV** key while navigating to a destination in Automotive Mode. Or, open the Map page and press **MENU**.
2. Select **Custom Avoids**. Press **ENTER**.
3. Press **ENTER** when the **Add Avoid** button is highlighted.
4. Select **Avoid Road** or **Avoid Area** and press **ENTER**.
5. Use the **Rocker** key to move the arrow to the first point in the avoidance area. Press **ENTER** to select the first point.
6. Move the arrow to the end point and press **ENTER**. During route calculation and navigation, the GPSMAP 276C will avoid the area within the box or the selected area of the road.
7. When finished, highlight the **OK** button and press **ENTER**.

Creating a Detour

If, while navigating a route, there is road construction or some other form of a detour, you can have your GPSMAP 276C create a detour route for you.

To create a Detour:

1. While navigating a course, press the **NAV** key.
2. Select **Detour** from the Navigate Menu.
3. Select the desired distance and press **ENTER**. The GPSMAP 276C will recalculate your course based upon your detour distance.
4. To end the detour manually, press **NAV** again and select **Cancel Detour**.

Adding and Editing Stops (Via Points)

You can add via points—points through which you would like to travel—to your route using the **Edit Vias** option. Via points are great for adding a stop at the gas station or bank to your route and are really helpful when planning a long trip.

To add via points to your route:

1. While navigating your route, press the **NAV** key to open the Navigate Menu.
2. Use the **Rocker** key to select **Edit Vias** and press **ENTER**.

3. The Add/Edit Vias window opens. Highlight **Add Via Point** and press **ENTER**.



Add/Edit Vias Page

Showing the original route without via points

4. From the pop-up window, highlight either **Use Map** or **Use Find Menu** and press **ENTER**.
5. If you selected **Use Map**, use the **Rocker** key to select the desired item on the map and press **ENTER**.
If you selected **Use Find Menu**, select an item from the Find Menu as discussed in the “[Finding an Item](#)” beginning on page 18. Remember you can press **MENU** while the Find Menu is open to find an item near another location, such as the destination.
6. The new point is added to the route as displayed in the Add/Edit Vias page. Continue steps 3 through 5 until you have added all of the via points that you want. Highlight **Done** and press **ENTER** to apply the new via points to the route.

Following an Automotive Route

The GPSMAP 276C guides you to your destination using many tools, such as the Map page and Current Route page.

Track your Progress with the Map Page

You can track the progress of your route on the Map page. Your route is shown with a magenta line. The next turn is displayed in the top bar on the Map page.

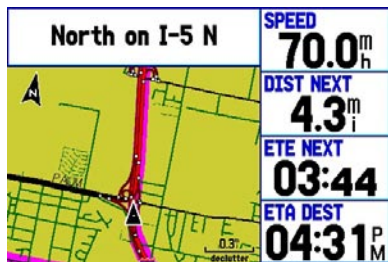

Map Page Displaying Your Route

Watch your Trip Data

Use the Trip Computer page to view your trip data. You can track your speed here, as well as other information related to your trip.

See your Next Turn with the Current Route Page

Whenever you have activated a turn-by-turn route in the GPSMAP 276C set in Automotive Mode, the Current Route page shows each turn of the active route. For more information see page 66.

	0.1 ^m	Turn right on Imperial Beach Blvd	00:13 04:10 ^R
	1.4 ^m	Take ramp to I-5 N on right	02:26 04:12 ^R
	6.4 ^m	Keep left on I-5 N	06:53 04:17 ^R
	9.8 ^m	Keep left on I-5 N	09:51 04:20 ^R
	22.1 ^m	Arrive at Point Loma Park and Recre on left	21:55 04:32 ^R

Current Route Page

AUTOMOTIVE MODE PAGES AND FEATURES

This section discusses the major pages in Automotive Mode, such as the Map page, as well as some additional features, such as Routes and Points. For information about pages and features not discussed here, refer to the “Marine Mode Pages and Features” section.

Map Page

Refer to page 43 in Marine Mode Pages and Features section for more details about the Map page.

In Automotive Mode, by default, four user-selectable data fields appear on the right side of the screen that can be configured to display any one of the possible data options. The top of the screen displays the GPS status or the route leg. You can also add additional data fields to the page or select a full screen map without data fields.



Press the zoom keys (**IN** and **OUT**) to change the map scale. Some items on the map are only displayed if the map is zoomed in to a certain level.

Press **ENTER** to quickly declutter (remove unwanted items) from the Map page.

Press **MENU** to open the options menu for the Map page.

Show and hide the heading line from the options menu.

Use the **Rocker** key to measure the distance between two objects on the map.

Change the page layout and data fields to customize the Map page. See page 78 for instructions.

Current Route Page

Whenever you have activated a route in the GPSMAP 276C in Automotive Mode, the Active Route Page shows each turn of the active route, with the distance to the turn, the street name, and estimated time to arrival and time of arrival. As you navigate a route, the turn list automatically updates to indicate the next turn at the top of the list.

	0.1 ^m	Turn right on Imperial Beach Blvd	00:13 04:10 ^R
	1.4 ^m	Take ramp to I-5 N on right	02:26 04:12 ^R
	6.4 ^m	Keep left on I-5 N	06:53 04:17 ^R
	9.8 ^m	Keep left on I-5 N	09:51 04:20 ^R
	22.1 ^m	Arrive at Point Loma Park and Recre on left	21:55 04:32 ^R

Current Route Page

You can scroll through the entire list by moving the scroll bar up or down. Highlight any of the turns on the list and press **ENTER** to view the Next Turn page for that turn. The Current Route and Next Turn page display similar information, just in a different layout. The Next Turn page displays your next turn on a map.

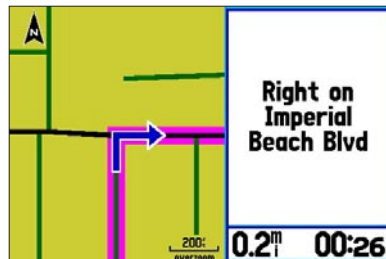

Next Turn Page

Saving the Current Route

You can save the current route from the Current Route page. Press **MENU** to save the route. Press **ENTER** when **Save Route** is highlighted. Your route is automatically saved, using the starting point and destination as the route name. Press **ENTER** when **OK** is highlighted to complete saving the route.

Trip Computer Page

The Trip Computer page displays important data while navigating a route in Automotive Mode. It indicates your current speed and other helpful data about your trip, such as average speed and moving time.

Trip Computer		
NW 09:31:35 ^A	70.0^m_h 000000.8 ^T	35.5^m_i 000035.5 ^T
Moving Average	Total Average	Maximum Speed
35.8^m_h	13.5^m_h	78.5^m_h
Moving Time	Stopped Time	Total Time
00:59:22	01:38:36	02:37:57

Trip Computer Page

Reset the Trip Computer before beginning a trip. If you make frequent stops, leave the GPSMAP 276C powered on in order to receive satellites. This allows the unit to accurately measure elapsed time during the trip.

Trip Computer Page Options Menu

The following options are available from the Trip Computer options menu. Some options are only available if you have changed the page layout. Press **MENU** to open the options menu. Highlight the desired option and press **ENTER**.

Trip Computer		
NW 09:31:35 ^A	Set Up Page Layout Reset Trip Reset Max Speed Reset Odometer Reset All	35.5^m_i 000035.5 ^T
Moving Average	(MENU) for Main Menu	Maximum Speed
35.8^m_h		78.5^m_h
Moving Time	Stopped Time	Total Time
00:59:22	01:38:36	02:37:57

Trip Computer Page Options Menu

Set Up Page Layout—allows you to choose the layout and number of data fields. You can change the layout of the Trip Computer to the Position Data Page layout while still in Automotive Mode. You can also then change the data fields on the Position Data Page to be more useful while in Automotive Mode.

Change Nearest Type—allows you to specify the type of item to be used as the nearest item (displayed in the lower-left data field of the Position Data (2 Columns) layout). The choices change based upon the Usage Mode you are currently using.

Select the **Reset** options to reset the maximum speed, the odometer, everything but the max speed and odometer, or reset everything in the trip computer.

ADDITIONAL PAGES AND FEATURES

The Main Menu features some additional pages that will be useful to you as you plan trips and use your GPSMAP 276C. Some of these pages have already been discussed in-depth in previous sections. This section only contains the additional pages and features found in the Main Menu that have not been discussed yet.

Press the **MENU** key twice to open the Main Menu.

Setting Alarms

The Alarms tab of the Main Menu allows you to define alarm settings. When an alarm goes off, the alarm message appears on the display and the unit emits five (5) beeps. When you set an alarm to be persistent, the alarm message appears on the display and the unit beeps until you press **ENTER** to acknowledge the alarm.

To set an alarm:

1. Press **MENU** twice to open the Main Menu.
2. Use the **Rocker** key to open the **Alarms** tab.
3. Highlight the alarm name to activate and press **ENTER**.
4. Change the mode to **On** (or the desired mode, where available) and press **ENTER**. If necessary, highlight the next field to the right and press **ENTER**, enter the desired settings, and press **ENTER** to finish.

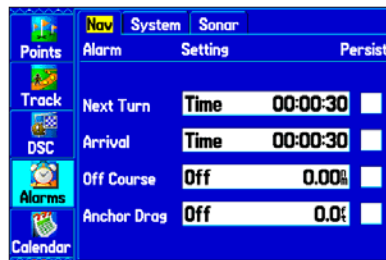

Navigation Alarms Tab

To set a persistent alarm:

1. Press **MENU** twice to open the Main Menu.
2. Use the **Rocker** key to open the **Alarms** tab.
3. Highlight the box next to the alarm you would like to make persistent (for example, **Restricted Areas**).
4. Press **ENTER** to place a check mark in the **Persist** box.

When an alarm goes off, it sounds until you acknowledge the alarm message by pressing **ENTER**.

Navigation (Nav) Alarms

Next Turn—sets an alarm to indicate the next turn in a route. Select **Dist** to enter a specific distance before you reach the next turn to sound the alarm. Select **Time** to enter a specific time before the turn for the alarm to go off. Select **Auto** for the unit to provide a Next Turn alarm at its discretion.

Arrival—sets an alarm to sound when you are a specified distance or time away from a destination waypoint. Select **Auto** for the unit to provide an Arrival alarm at its discretion.

Off Course—sets an alarm to sound when off your desired course. Select **On**, then enter a distance.

Anchor Drag—sets an alarm to sound when you have exceeded a specified drift distance. Select **On** and then enter a distance.

System Alarms

Clock—sets an alarm based on the unit's clock. Select **On** and then enter a specific time that you want the alarm to sound. The unit must be on for the clock alarm to work.

Ext. (External) Voltage—sets an alarm to sound when the external voltage drops below a specified amount. Select **On** and then enter a specific voltage.

DGPS—sets an alarm to sound when the unit loses a differential fix.

Accuracy—sets an alarm to sound when GPS accuracy falls outside of the user-set value. Select **On** and then enter a specific distance.

Sonar Alarms

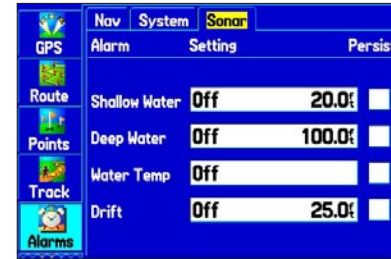

Sonar Alarms Tab

Shallow Water/Deep Water—sets an alarm to sound when you enter an area of water that is too shallow or deep. Select **On** and then enter a specific distance. You must be receiving sonar NMEA data for this function to work.

Water Temp—sets an alarm to indicate if the water temperature has exceeded or dropped below a specific temperature, or fallen outside/inside a specific temperature range. Select **Above** or **Below** and then enter a specific temperature, or select **Inside** or **Outside** and enter a range of temperatures. You must be receiving sonar NMEA data for this function to work.

Drift—sets an alarm to sound when you have exceeded a specified drift distance. Select **On** and then enter a specific distance.

Fish—sets an alarm to sound when fish are detected with sonar.

Using the Calendar

The Calendar allows you to plan trips while also displaying sun and moon and hunting and fishing information for the day.

To add a route (or point) to the calendar:

1. Press **MENU** twice to open the Main Menu.
2. Highlight **Calendar** from the vertical list of tabs. The current day is displayed in Day View.

*Highlight an arrow and press **ENTER** to change the date in the view.*



Calendar Tab in Day View

3. Press the **MENU** key to display the options menu. Highlight **Add Route** (or **Add Point**) and press **ENTER**.
4. From the pop-up route list (or the Find Menu if Add Point was selected), select the route you want to add to the calendar and press **ENTER**.

Day View

The Day View displays sunrise and sunset times for your current date and location. A list of points and routes for the day are displayed in a list, as shown to the left. You can select a different date by highlighting an arrow and pressing **ENTER**. Press **MENU** to display an options menu.

Week View

The Week View provides many of the same elements as Day view, but the entire week is visible. Days with points or routes added to them are shown highlighted in green. Icons for the points and routes assigned to the date are shown along the bottom of the screen.

Month View

The Month View provides many of the same elements as Day view, but the entire month is visible. Days with points or routes added to them are shown highlighted in green. Icons for the points and routes assigned to the date are shown along the bottom of the screen.

Calendar Options

The options menu is available in all three calendar views. Press **MENU** on any of the calendar views to open the options menu. To jump to the Sun & Moon Information or Hunt & Fish tab, highlight **View Sun and Moon** or **View Hunt and Fish** and press **ENTER**.

Viewing Celestial Information

The Celestial tab of the Main Menu displays tide information, sun and moon information, and hunting and fishing information. You may display this data for your current position, a position from the map, or a waypoint location. Also, you may select a different date and time, or use the current data.

To access the Celestial Tabs of the Main Menu:

1. Press **MENU** twice to open the Main Menu.
2. Highlight **Celestial** from the vertical list of tabs.
3. Use the **Rocker** key to display the desired tab, such as **Sun & Moon** & **Moon**.

Tide Tab

The Tide tab contains a graphical chart that displays tide station information in a 24-hour span starting at midnight station time. You can choose from different dates and over 3000 tide stations.

Enter the Date for which you want to view the tide information. *Select the Tide Station for which you want to view the information.*

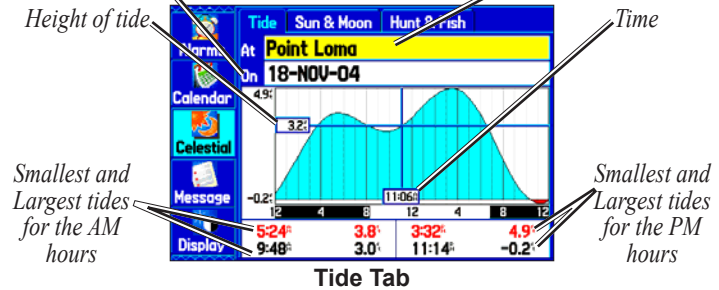

The top of the page displays the tide station and date being referenced. The chart shows a 24-hour block of time, with the time progressing from left to right. The solid vertical lines represent 4-hour increments; the dotted vertical lines represent 1-hour increments.

The tide curve appears as a shaded area; higher tides are taller and lower tides are shorter. The bottom of the page indicates the times with the highest and lowest tides.

To view a tide chart for a different tide station:

1. From the Tide tab, highlight the **At** field and press **ENTER**. The Find Menu opens showing the Tide Stations.
2. Press **MENU** and select **Near Current Location, Near Current Route, Near Other** (select another location using the map), or **Near Destination** if desired. The list is then updated with your search requirements.
3. Select the desired station from the list and press **ENTER**.
4. The Tide Station Information page opens. Highlight **OK** and press **ENTER**.
5. The Tide tab displays again showing the tide chart for the selected tide station.

To view the tide chart for another date:

1. From the Tide tab with the desired chart displayed, highlight the **On** field and press **ENTER**.
2. **ENTER** the desired date with the **Rocker** key and press **ENTER**. You can also use the **Zoom IN** and **OUT** keys to view information for another date. Press and hold **IN** or **OUT** to scroll quickly through dates.
3. Press **ENTER** when finished. The unit displays the chart for the date you entered or selected.

To use the current date again, highlight the **Date** field. Press **MENU**, highlight **Use Current Date**, and press **ENTER**.

To view a chart's details for another time during the day (other than current time):

1. From the Tide tab with the desired chart displayed, press **MENU** and select **Move Cursor**.
2. Press the **Rocker** key Right or Left to view the chart at another time.
3. To return to the current time, press **MENU** and select **Stop Moving Cursor**.

To automatically start cursor mode to scroll the chart:

1. Use the **Rocker** key to highlight the **Date** field. Then press Down to activate the cursor (pan) mode.
2. Scroll the chart right to view the next day or left to view the previous day.

Sun & Moon Tab

The Sun & Moon tab provides you with sun rise/set and moon rise/set times. A graphic display of the moon phase is also displayed. You may view Sun & Moon information for any date or location. You can also use the play, fast forward, and stop buttons to view an animation of the Sun & Moon tab.

To view Sun & Moon information for a different date:

1. Use the **Rocker** key to highlight the **Date** field and press **ENTER**.
2. Use the **Rocker** key to change the digits of the date to the desired date. You can also use the **Zoom IN** and **OUT** keys to view information for another date. Press and hold **IN** or **OUT** to scroll quickly through dates.
3. Press **ENTER** when finished. The unit displays the sun and moon information for the date you entered or selected.

To use the current date again, highlight the **Date** field. Press **MENU**, highlight **Use Current Date**, and press **ENTER**.

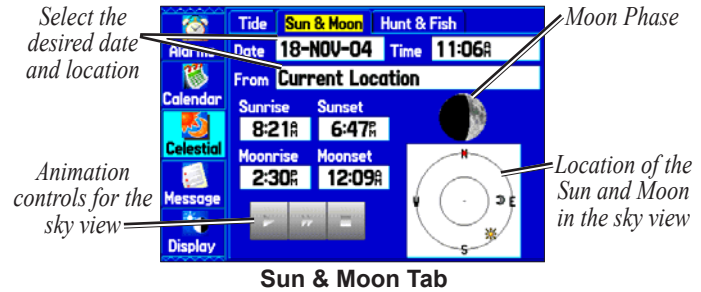

To view Sun & Moon information for a different location:

1. Use the **Rocker** key to highlight the **From** field and press **ENTER**.
2. Highlight **Use Find Menu** and press **ENTER**. The Find Menu automatically opens.
3. Select a waypoint or point of interest and press **ENTER**.
4. On the waypoint information page, press **ENTER**. The unit displays the sun and moon information for the location you selected.

To use the current location, highlight the **From** field. Press **ENTER**, highlight **Current Location**, and press **ENTER**.

Hunt & Fish Tab

The Hunt & Fish tab provides you with predictions of the good and best times to hunt and fish in a selected location on a specific date.

To display the Hunt & Fish information:

1. Press **MENU** twice to open the Main Menu.
2. Highlight **Celestial** from the vertical list of tabs using the **Rocker** key.
3. Use the **Rocker** key to display the Hunt & Fish tab.

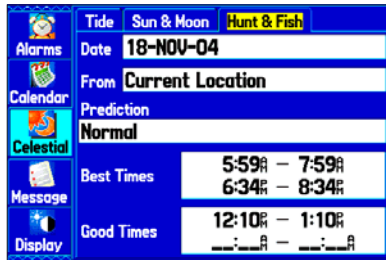

Hunt & Fish Tab

To view Hunt & Fish information for a different date:

1. Highlight the **Date** field and press **ENTER**.
2. Use the **Rocker** key to change the digits of the date to the desired date. You can also use the **Zoom IN** and **OUT** keys to view information for another date. Press and hold **IN** or **OUT** to scroll quickly through dates.
3. Press **ENTER** when finished. The unit displays the information for the date you entered.

To use the current date again, highlight the **Date** field. Press **MENU**, highlight **Use Current Date**, and press **ENTER**.

To view Hunt & Fish information for a different location:

1. Use the **Rocker** key to highlight the **From** field and press **ENTER**.
2. Highlight **Use Find Menu** and press **ENTER**. The Find Menu automatically opens.
3. Select a point and press **ENTER**.
4. On the information page, press **ENTER**. The unit displays the Hunt & Fish information for the selected location.

To use the current location, highlight the **From** field. Press **ENTER**, highlight **Current Location**, and press **ENTER**.

Viewing Messages

The Message tab of the Main Menu displays a list of messages generated by your GPSMAP 276C. Use the **Rocker** key to scroll through the entire list of messages on the Log tab. Use the Log Filter tab to display only the message types that you want to view.

To view the messages:

1. Press **MENU** twice to open the Main Menu.
2. Highlight **Message** from the vertical list of tabs.

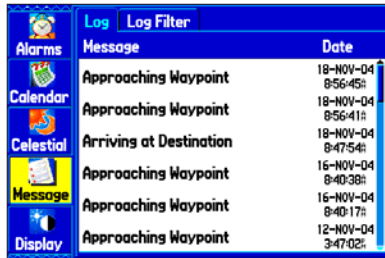

Log	Log Filter	Message	Date
Alarms		Approaching Waypoint	18-NOV-04 8:56:45h
Calendar		Approaching Waypoint	18-NOV-04 8:56:41h
Celestial		Arriving at Destination	18-NOV-04 8:47:54h
Message		Approaching Waypoint	16-NOV-04 8:40:38h
Display		Approaching Waypoint	16-NOV-04 8:40:17h
		Approaching Waypoint	12-NOV-04 3:47:02h

Message Log Tab

3. Use the **Rocker** key to highlight the desired message. Press **ENTER** to view detailed information about that message.

To show/hide messages using the Log Filter:

1. Press **MENU** twice to open the Main Menu.
2. Highlight **Message** from the vertical list of tabs.
3. Use the **Rocker** key to highlight the **Log Filter** tab. By default all messages are displayed.



Log	Log Filter	Show	Hide
Alarms		Accuracy Alarm	
Calendar		Alarm Clock	
Celestial		Anchor Drag Alarm	
Message		Antenna Shorted	
Display		Approaching Waypoint	
		Arriving at Destination	
		Saveset Failed	
		Batteries Low	
		Calendar Memory Full	
		Can't Unlock Maps	
		Database Error	
		Deep Water Alarm	
		Directory Memory is Full	
		Distress Call	
		Drift Alarm	

Message Log Filter Tab

4. Use the **Rocker** key to highlight the message you want to hide and press **ENTER**.
5. The message name then appears in the **Hide** window. Highlight the message and press **ENTER** to show it again.

Viewing the Temperature



NOTE: You must be receiving proper sonar data from another device, such as a Garmin GSD 20 Sounder Module, to view temperature information.

The Temperature tab provides a visual graph of water temperature changes over a period of time. The graph reads from right to left so that the most recent temperature measured is displayed on the far right side of the graph. The dotted lines within the graph indicate intervals in the temperature scale and the duration of time.



NOTE: Select **Temp** for the **Transducer** type in the **Sonar Setup**. See “[Setting up the Sonar](#)” on page 96 for more information.

Press **MENU** two times to open the Main Menu. Select **Setup** from the vertical row of tabs on the left, then select **Temperature** from the row of tabs along the top of the screen.

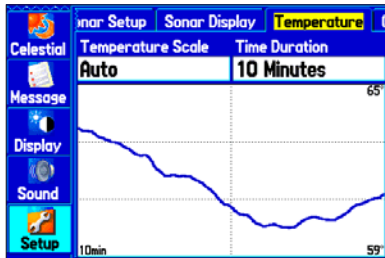

Temperature Tab

Changing the Temperature Display

The graph will adjust and display the temperatures changes according to the **Temperature Scale** and **Time Duration** settings.

Temperature Scale—select the desired degree span from the list. Select **Auto** to have the unit automatically determine the best range, or select a span of 2, 4, 6, 8 or 10 degrees.

Time Duration—set how fast or slow the temperature log scrolls; a shorter time duration means a faster temperature log scroll. Select a duration from 1 minute to 2.5 hours.

Reset the Temperature Graph

To reset the scale range for the temperature graph, press **MENU**, highlight **Reset Auto Scale**, and press **ENTER**. This is useful when the scale spans a large range due to extreme temperature changes. You can only reset the scale when you select **Auto** for the **Temperature Scale**.

To restore the temperature graph to defaults, press **MENU**, highlight **Restore Default**, and press **ENTER**.

CUSTOMIZING YOUR GPSMAP 276C

The Main Menu provides access to various waypoint, system, navigation and interface management, and setup menus.

Setting up the System

To customize how your GPSMAP 276C looks and sounds, adjust certain system settings in the Main Menu.

Adding a Welcome Message

The Welcome tab allows you to enter information, such as your name and address, that the unit can display when it is turned on. This feature can be helpful if your unit is ever misplaced.

To open the Welcome tab, press **MENU** twice to open the Main Menu. Select **Setup** from the vertical tab list. Then select **Welcome** from the row of tabs along the top of the page.

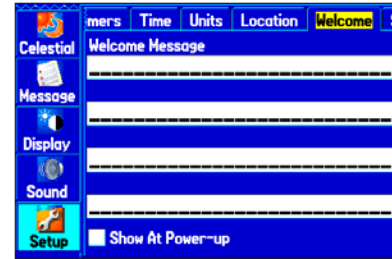

Welcome Tab of the Setup Tab

Enter the desired information in the fields. You do not need to enter information in every field.

To display this information at power up, highlight the box next to **Show at Power-up**. Press **ENTER** to place a check mark in the box. To hide the welcome information at power-up, remove the check mark from the box.

Changing the Page Layout and Data Fields

You can adjust how the following pages look on the screen: Map, Compass, Highway, Position Data, Trip Computer, and optional Sonar page. You can adjust the data fields on all of those pages too.

To set up the page layout:

1. Press **PAGE** to display the page you want to change.
2. Press **MENU** to open the options menu.
3. Highlight **Set Up Page Layout** and press **ENTER**.
4. Select the desired option and press **ENTER**. The options vary between the three usage modes and the page you are setting up.

To change a data field display:

1. Press **PAGE** to display the page you want to change.
2. Press **MENU** to open the options menu.
3. Highlight **Change Data Fields** and press **ENTER**
4. Highlight the data field you want to change and press **ENTER**.
5. Press Up or Down on the **Rocker** key to highlight the type of data you want to display and press **ENTER**.
6. Press **QUIT** to exit.

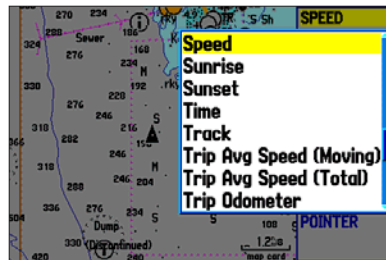

Changing a Data Field

Setting up the Map Page

The Map page Setup allows you to adjust the way items are displayed on the Map page.

To change a map setup option:

1. From the Map page, press **MENU** to open the options menu.
2. Highlight **Set Up Map** and press **ENTER**.
3. Press Left or Right on the **Rocker** key to highlight the desired file tab, then Up or Down on the **Rocker** key to highlight to the field you want to change and press **ENTER**.
4. Press Up or Down on the **Rocker** key to highlight the desired setting and press **ENTER**.
5. Press **PAGE** or **QUIT** to exit.

Additional Map Data Displayed

You can view the data that is currently loaded on your GPSMAP 276C unit and data card.

To review/change map information:

1. Access the Map page and press **MENU**.
2. From the options menu, highlight **Map Information** and press **ENTER**.

*Map Family highlighted. Press **ENTER** to view the individual maps in the family.*

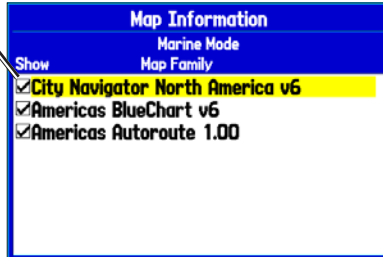

Data Card Information Page

3. The first page shows the Map Families stored on the data card and unit and whether they are shown on the Map page. To change the setting for a Map Family, highlight the box next to the Map Family name and press **ENTER** to select (check mark) or deselect (no check mark) the **Show** setting.
4. To view the list of maps within a Map Family, highlight the name of the Map Family and press **ENTER**.

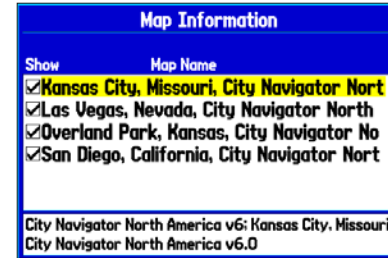

Individual Map Information Page

Showing the individual maps that are in the selected Map Family

5. To view detailed information about an individual map, highlight the Map Name and press **ENTER**. Highlight **OK** and press **ENTER** to exit the map information page.
6. To select/deselect individual maps for display on the Map page, highlight the box next to the desired map and press **ENTER** to check/uncheck the **Show** box. Or, press **MENU**, select one of the options (**Show All**, **Hide All**, or **Show Defaults**), and press **ENTER**.
7. Press **QUIT** to exit the Map Information page.

Changing the Display

The Display tab of the Main Menu allows you to set several features of the display, such as what pages to display in the Main page sequence and how long the backlight stays on.

To view the Display tab:

1. Press **MENU** twice to open the Main Menu.
2. Highlight **Display** from the vertical list of tabs.



Display Tab

Color Mode—sets the display to **Day**, **Night**, or **Auto** color mode. Select **Auto** to automatically switch from day to night at sunset and change back at sunrise.

Main Menu—enables the main menu tabs to contain text and icons (default) or text tabs only.

Backlight Timeout—sets the backlight to stay on once it is turned on, or to time out after a selected period of time has elapsed when using the battery. The backlight stays on regardless of this setting when external power is used.

Twilight Adjustment—allows the unit to adjust the backlight for optimum viewing during twilight times.

Highway Page—enables the page and places it in the Main page sequence.

Compass Page—enables the page and places it in the Main page sequence.

Backlight Intensity—turns the backlight up or down. Press the **Rocker** key Right to increase the intensity or Left to decrease.

Changing the Sounds

The Sound tab of the Main Menu allows you to customize the sounds your GPSMAP 276C makes to suit your needs.

To view the Sound tab:

1. Press **MENU** twice to open the Main Menu.
2. Highlight **Sound** from the vertical list of tabs.

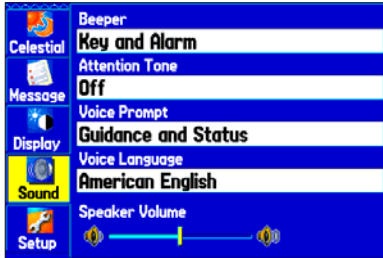

Sound Tab

Beeper—sets the beeper to chime during keypresses and alarms (**Key and Alarm**) or on **Alarms Only**.

Attention Tone—turns on and off the attention tone that sounds before the vocal prompts.

Voice Prompt—sets the vocal prompt to operate for **Guidance and Status**, **Route Guidance Only**, or **No Voice Prompts**.

Voice Language—sets the language for vocal prompts.

Speaker Volume—sets the external speaker volume (when used). Press the **Rocker** key Right to increase the volume or Left to decrease.

Changing the System Settings

To open the System tab, press **MENU** twice to open the Main Menu. Select **Setup** from the vertical tab list. Then select **System** from the row of tabs along the top of the page.

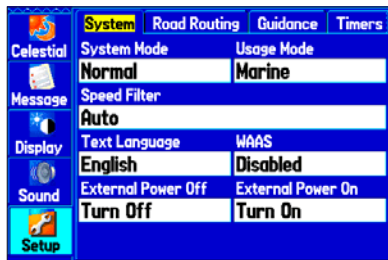

System Setup Tab

System Mode—sets the unit to operate in **Normal** mode, **Battery Saver** mode, or **Simulator** mode (for practice ONLY).

Usage Mode—sets the unit to the desired mode.

Speed Filter—allows the unit to average speed readings. Choose from **Off**, **Auto** (automatically controls filtering), or **On** (allows you to enter a value in seconds).

Text Language—allows you to select from various languages for the unit's on-screen display.

WAAS—disable and enable WAAS from this field.

External Power Off—allows you to select whether the GPSMAP 276C remains on (**Stay On**) or the unit turns off (**Turn Off**) when external power is removed from the unit.

External Power On—allows you to turn the GPSMAP 276C on (**Turn On**) or charge the battery (**Charge Battery**) when external power is applied to the unit.

Setting the Timers

To open the Timers tab, press **MENU** twice, select **Setup** from the vertical tab list, and **Timers** from the row of tabs along the top.



Timers Tab of the Setup Tab

User—allows you to set the timer to **Count Up** or **Count Down**. You can also **Reset** the timer and turn it **Off**. Enter a time to use when counting up or down to the right.

Marine—displayed on the Compass page. See page 49.

Since Midnight—the time the unit has been turned on since midnight. This will reset if you restore **All Unit Defaults** from the **System** tab.

Changing the Time

The Time tab allows you to set the time format and zone. You can also set the unit to conform to Daylight Saving Time. The current time and date are displayed at the bottom of the page.

To open the Time tab, press **MENU** twice, select **Setup** from the vertical tab list, and **Time** from the row of tabs along the top.



Time Tab of the Setup Tab

Time Zone—allows you to choose a city in your correct time zone so the GPSMAP 276C will show the correct local time. Select **Other** to enter a UTC Offset.

If the incorrect date is displayed, press **MENU**, highlight **Set Date**, and press **ENTER**. You will then be prompted to enter the current year. The GPSMAP 276C will use this information when gathering satellite data to display the correct date.

Customizing the Units

The Units tab allows you to customize measurement units for the entire system. To open the Units tab, press **MENU** twice to open the Main Menu. Select **Setup** from the vertical tab list. Then select **Units** from the row of tabs along the top of the page.



Units Tab

Distance and Speed—select the unit to display your speed and distance traveled.

Direction Display—select the unit to display your direction. Mils is a unit of angle measurement used in military settings, in which 17.78 mils equal one degree.

Temperature—select the unit to display the temperature.

Elevation—select the unit to display your altitude.

Depth—select the unit to display the depth.

Restoring Defaults

The following tabs in the Main Menu allow you to restore their defaults: Track, Alarms, Display, Sound, and Setup.

To restore defaults:

1. Press **MENU** twice to open the Main Menu.
2. Use the **Rocker** key to highlight the desired tab.
3. Press **Menu** to open the options menu.



Setup Tab Options Menu

4. Highlight **Restore Default**.
5. Press **ENTER** to restore the tab to the defaults.

To restore all of unit's settings to the factory defaults at once, select **All Unit Defaults** from the options menu of the Setup tab.

Customizing the Routing and Guidance Settings

You can change the way the GPSMAP 276C generates routes in Automotive Mode. You can also change the way the GPSMAP 276C guides you during navigation.

Road Routing Settings

To open the Road Routing tab, press **MENU** twice to open the Main Menu. Select **Setup** from the vertical tab list. Then select **Road Routing** from the row of tabs along the top of the page.

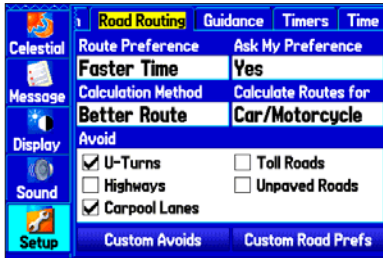

Road Routing Setup Tab

Route Preference—allows the unit to calculate routes based on:

- **Faster Time**—routes calculated are faster to drive but may be longer in distance.
- **Shorter Distance**—routes calculated are shorter in distance but may take more time to drive.
- **Off Road**—creates a direct line from your current location to your destination. This is useful when you are travelling outside of the detailed map coverage area or where no roads exist.

Ask Me My Preference—determines whether you will be asked to select a Route Preference before route calculations.

Calculation Method—sets how the unit searches for the route.

- **Quickest Calculation**—calculates the route the quickest, but it might not produce the best route.
- **Quick Calculation**—takes a bit more time to calculate but generates a better quality route.
- **Better Route**—generates an even better quality route but uses a longer calculation time.
- **Best Route**—generates the most optimal route but takes the longest time to calculate.

Calculate Routes for—sets route calculation for the particular vehicle you are operating to optimize the route for your vehicle type, as some roads have vehicle-based restrictions.

Avoid—allows you to avoid certain road types and maneuvers on your route. The unit uses these road types only if alternative routes take you too far out of your way or if no other road is available.

Custom Avoids—allows you to enter specific areas and roads that you would like to avoid in your navigation. Refer to page 62 for information on creating custom avoids.

Custom Road Prefs—allows you to avoid or use **Major**, **Medium**, and **Minor** roads using a slider scale. This is especially nice if you want to avoid major highways, for example. Select **Auto Set** to use preset values.

Guidance Settings

To open the Guidance tab, press **MENU** twice to open the Main Menu. Select **Setup** from the vertical tab list. Then select **Guidance** from the row of tabs along the top of the page.

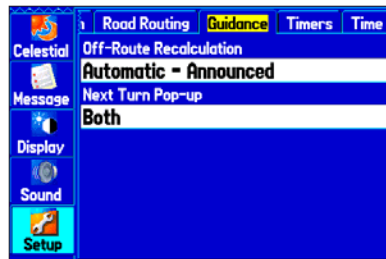

Guidance Tab of the Setup Tab

Off-Route Recalculation—allows you to set whether the unit prompts you when it is recalculating your route (**Prompted**), or whether the unit recalculates automatically. Set whether the unit announces the recalculation (**Automatic - Announced**) or recalculates silently (**Automatic - Silent**). You can also turn the off-route recalculation **Off**.

Next Turn Pop-up—turns the Next Turn pop-up window **Off**, or opens the window when you hold the NAV key (**Held NAV Key Only**), opens automatically (**Automatically Only**), or **Both**.

Changing the Location Settings

To open the Location tab, press **MENU** twice to open the Main Menu. Select **Setup** from the vertical tab list. Then select **Location** from the row of tabs along the top of the page.

Refer to the “Appendix” of this guide for more information about location formats and map datums. Also visit the National Imagery and Mapping Agency at <http://www.nima.mil> for more information on grids and datums.

Changing the Location Format

When you change the **Location Format**, you change the coordinate system in which a given position reading is displayed. The default format is latitude and longitude in degrees, minutes, and thousandths of a minute (hddd°mm.mmm).

You should only change the position format if you are using a map or chart that specifies a different position format or want to use a format you are familiar with.

Selecting a Different Map Datum

Datums are used to describe geographic positions for surveying, mapping, and navigation and are not actual maps built in the unit. You should only change the datum if you are using a map or chart that specifies a different datum.

The default setting is WGS 84. The unit automatically chooses the best datum depending upon your chosen position format.



WARNING: *Selecting the wrong map datum can result in substantial position errors. When in doubt, use the default WGS 84 datum for best overall performance.*

Selecting a Different Heading Reference

You can select from **Auto Mag Var**, **True**, **Grid**, and **User Mag Var**. **Auto Mag Var** provides magnetic north heading references that are automatically determined from your current position. **True** provides headings based upon a true north reference. **Grid** provides headings based on a grid north reference (and is used in conjunction with the grid position formats).

User Mag Var allows you to specify the magnetic variation at your current position and provides magnetic north heading references based upon the variation you enter. Enter the magnetic variation of your current position in the **Magnetic Variation** field if you have selected **User Mag Var** for the heading.



WARNING: *If User Mag Var is selected, the unit does not automatically calculate and update the magnetic variation at your present position. You must update the magnetic variation as your position changes. Failure to update this setting may result in substantial differences between the information displayed on your unit and external references, such as a magnetic compass.*

Changing the Data Format

The COM 1 and COM 2 tabs allow you to control the input/output format used when connecting your unit to external devices. To open the COM 1 or COM 2 tab, press **MENU** twice to open the Main Menu. Select **Setup** from the vertical tab list. Then select **COM 1** or **COM 2** from the row of tabs along the top of the page.

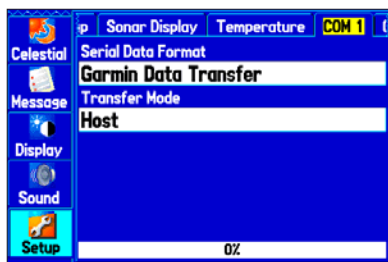

COM 1 Tab of the Setup Tab

Serial Data Format—sets the data format to one of the following:

- **Garmin Data Transfer**—the proprietary format used to exchange data with a PC or another Garmin GPSMAP 276C. Garmin Data Transfer is disabled when the USB is connected, and the unit automatically switches to USB format. When the USB is disconnected, the USB field changes to Transfer Mode, as shown above.

- **GARMIN DGPS**—used to connect the GPSMAP 276C with a Garmin DGPS beacon receiver.
- **NMEA In/NMEA Out**—supports the input/output of standard NMEA 0183 version 3.01 data and sonar NMEA input support for the DPT, MTW, and VHW sentences.
- **Text Out**—allows the unit to output simple text data that includes, data, time, position, and velocity. The Baud can be set to 1200, 2400, 4800, or 9600.
- **RTCM In**—allows Differential GPS (DGPS) input using a standard RTCM format.
- **RTCM In/NMEA Out**—allows Differential GPS (DGPS) input using a standard RTCM format and also provides NMEA 0183 version 3.01 output.
- **RTCM In/Text Out**—allows Differential GPS (DGPS) input using a standard RTCM format and also outputs simple text data that includes, data, time, position, and velocity.
- **None**—provides no interfacing capabilities.

If you select GARMIN DGPS or RTCM In/NMEA Out format, you can control a differential beacon receiver directly from your GPSMAP 276C using the COM tab. You can have the unit automatically scan for the DGPS beacon signal, or you can enter the beacon frequency and bit rate on the unit, and the information will be used to tune the beacon receiver. If you use a DGPS receiver, WAAS capability is automatically turned off.

To have the unit automatically scan for a frequency:

1. Set the unit to GARMIN DGPS or RTCM In/NMEA Out.
2. Highlight the **Beacon** field and press **ENTER**.
3. Highlight **Scan** and press **ENTER**. The numbers in the **Frequency** field change as the unit scans from 284 kHz to 325 kHz, 200 bit rate, then 100, at 6-second intervals.

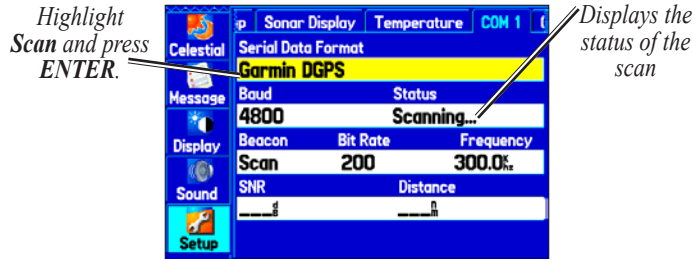

COM 1 tab of the Setup tab with GARMIN DGPS selected

The Status field displays one of the following:

- **Tuning**—the unit is attempting to tune to the specified frequency and bit rate.
- **Scanning**—the unit is automatically scanning through the frequencies and bit rates.
- **Receiving**—the unit is receiving DGPS signal and ready for operation.
- **Check Wiring**—the unit is not making connection with DGPS receiver.

To restart the scan:

1. Press **MENU**.
2. Highlight **Restart Scan** and press **ENTER**.

To manually enter a frequency and bit rate:

1. With the unit set to **GARMIN DGPS** or **RTCM In/NMEA Out**, use the **Rocker** key to highlight the **Beacon** field and press **ENTER**.
2. Highlight **User** and press **ENTER**.
3. Highlight the **Frequency** or **Bit Rate** field, press **ENTER**, and enter a frequency or bit rate. Press **ENTER** when done.

When the unit is receiving a DGPS signal, the SNR (Signal to Noise Ratio) and Distance fields show data. The SNR range is 0 dB to 30 dB, with 30 being the best. The Distance may or may not show data, depending upon the signal being broadcast from the DGPS site.

The DGPS beacon transmitters are operated by the United States Coast Guard (or similar government agency in other countries), which is responsible for their accuracy and maintenance. For DGPS transmitter problems or to find the most updated list of frequencies and coverage areas, contact your local USCG or see their Web site at <http://www.navcen.uscg.mil/>.

Advanced NMEA Output Setup

If you are going to interface the GPSMAP 276C with another piece of equipment (such as a radar or autopilot), the unit needs to be set to output NMEA data. The NMEA data transmission can be customized to keep the output rate at two seconds. If too many NMEA sentences are activated, the unit may take longer than two seconds to update.

To access the Advanced NMEA Output Setup:

1. Press **MENU** twice to open the Main Menu.
2. Use the **Rocker** key to select **Setup** from the vertical tab list.
3. Select **COM 1** or **COM 2** from the row of tabs along the top.
4. Highlight the field below **Serial Data Format**. Press **ENTER**.

5. Select **NMEA In/NMEA Out**. Press **ENTER**.
6. Press **MENU** to open the options menu. Select **Advanced NMEA Setup** and press **ENTER**.

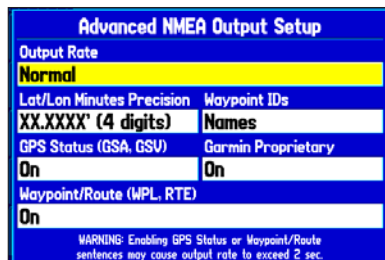

Advanced NMEA Output Setup

The Advanced NMEA Output Setup page allows you to set the output rate, change the precision of the Lat/Lon minutes, set Waypoint IDs to names or numbers, and turn on and off the GPS status, the GARMIN Proprietary sentences, and Waypoint/Route (WPL, RTE).

GPSMAP 276C NMEA Sentence Output (NMEA version 3.01 compliant):

- Always transmitted: GPRMC, GPGGA, GPGLL, GPBWC, GPVTG, GPXTE, GPRMB
- Switchable sentences: GPGSA, GPGSV, GPWPL, GPRTE
- GARMIN proprietary: PGRME, PGRMZ, PGRMM

SETTING UP AND USING SONAR

This section covers the additional sonar options for the GPSMAP 276C when used in conjunction with a GSD 20 Sounder Module. Read the *GSD 20 Sounder Module Installation Instructions* to properly install the sounder module. When you turn on your GPSMAP 276C, the Sounder Module automatically turns on.



NOTE: You **MUST** have a GSD 20 installed and connected to your GPSMAP 276C to use the sonar features.

The Sonar page is added to the end of the page sequence when you are in Marine Mode. To view the Sonar page, press **PAGE** or **QUIT** repeatedly until it is displayed.

Showing Sonar on the Map Page

You can change the layout of the Map page to display a split screen to show the sonar on the Map page. You must be in Marine Mode to use the sonar feature.

To display the Sonar page on the Map page:

1. Press and hold **PAGE**. Highlight **Marine** and press **ENTER**.
2. Press **PAGE** or **QUIT** to display the Map page.
3. Press **MENU**. Use the **Rocker** key to highlight **Set Up Page Layout** and press **ENTER**.
4. Highlight **Map with Sonar** and press **ENTER**.

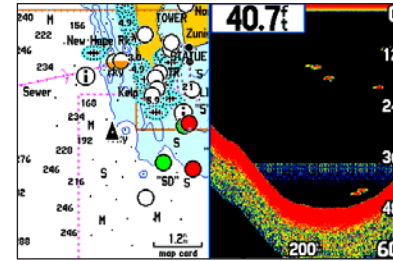

Map Page with Split Screen

To resize the Map page sonar split screen:

1. After displaying the Sonar and Map page together in the split screen, as described in the previous steps, press **MENU**.
2. Highlight **Size Split** and press **ENTER**.
3. Use the **Rocker** key to move the vertical double-arrow Right or Left until the screen is divided how you want it.
4. Press **ENTER** to complete the size split.
5. To stop resizing the screen, simply press **QUIT**. You can also press **MENU**, highlight **Stop Resizing**, and press **ENTER** to stop resizing the screen and retain the previous split setting.

Using the Sonar Page

When combined with a GSD 20 Sounder Module, your GPSMAP 276C becomes a powerful fishfinder/flasher with the Sonar page. If a GSD 20 is attached, but the unit does not detect a transducer, a “Sonar Turned Off” message appears across the Sonar page. If a GSD 20 is not attached, the Sonar page only appears when the unit is in Simulator Mode.

The middle of the page contains a right-to-left moving sonar image of the water beneath your boat. Items appear as they pass under your transducer. Those items on the right side of the screen are closer to you than those on the left. Along the right side of the screen is an adjustable scale that reflects the depth of the area being displayed. The top left corner displays the Adjustment Option, the depth, and the water temperature.

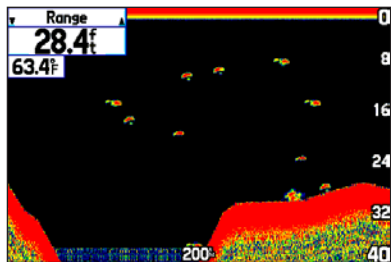

Sonar Page

The sonar returns show as red (strongest), then oranges (strong), yellows (medium), greens (weaker), and blues (weakest). The **Fish Symbols** option allows you to view the actual sonar data, a fish symbol or a combination of both. When the unit is set to **Dual**, the appearance of the fish symbols changes. Fish symbols from the center of the beam (200 kHz) are solid (or narrow arches), but the returns from the edges of the beam (50 kHz) are hollow (or wide arches).

The sonar display may also be set to show a split screen view of a zoomed portion of the sonar, bottom lock (display scaled from the bottom up), or a combination of these options. For example, you may choose to show dual frequency at a 2X zoom (Dual 2X) on one half and normal range dual frequency (Dual) on the other half. The current display mode is displayed at the bottom of each sonar display.

Read the “[Understanding Sonar](#)” section beginning on page 99 for more on information about sonar.

Adjusting the Sonar Page

The Adjustment Menu allows direct access to the settings and features most commonly used on the Sonar page. There are ten main adjustment options available: Range, Zoom, View, Gain, Target Level, Whiteline, Frequency, Depth Line, Noise Reject, and Scroll. Use the **Rocker** and **ENTER** keys to make all adjustments. The currently selected option appears in the upper left corner.

To select an adjustment option:

Use one of the following methods to select an adjustment option:

- Press the **Rocker** key right or left to scroll through the adjustment options. When the desired adjustment option is displayed, press **ENTER**.
- Press **MENU**, highlight **Adjustments**, and press **ENTER**. Use the **Rocker** key to highlight the desired adjustment and press **ENTER**.

Once you have selected an adjustment option, press the **Rocker** key Up or Down to change the setting.

You may also press **MENU** and highlight the desired shortcut setting to quickly change to commonly used settings/values.

Press **ENTER** to accept the new setting (or press **QUIT** to cancel) and return to the Sonar page.

Adjustment Options

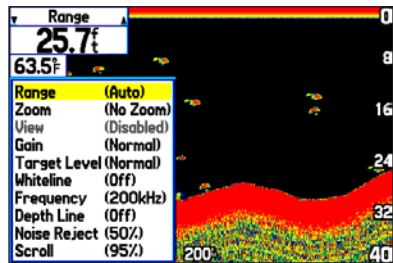

Sonar Adjustments

Scroll—adjusts the rate that the sonar display scrolls from right to left. If you are sitting still or the sonar display is moving too fast, slow the scroll rate or pause the scrolling.

Range—sets the display depth range used for viewing. The unit can be set to automatically track the bottom or set to a user-specified depth range.

Zoom—used to quickly select a display zoom scale or to split the display. When a scale other than **No Zoom** is selected, the Adjustment Menu displays a new selection labeled **View** or **Span**. The Zoom function is divided into six display levels:

- **2X Split**—shows two reduced-size sonar pictures at the same time. The right half of the display screen shows the complete sonar picture at its original scale. The left half shows a portion of the original picture at 1/2 depth scale.
- **2X Zoom**—displays the 2X zoomed picture on the full screen.
- **4X Split**—shows two reduced pictures, the right at the original depth scale and the left at 1/4 the original depth scale.
- **4X Zoom**—displays the 4X zoomed picture on the full screen.
- **Btm (Bottom) Split**—shows two reduced pictures, the right at the original depth scale and the left showing sonar returns from the bottom up. All target depths read as a distance from the bottom.
- **Btm (Bottom) Lock**—displays returns from the bottom up on the full screen.



***TIP:** Quickly zoom in and out of the Sonar display by pressing the **IN** and **OUT** keys. Deactivate the zoom function by pressing the **OUT** key until the **No Zoom** setting appears.*

View/Span—available when a **Zoom** scale other than **No Zoom** is selected. The **View** or **Span** setting is used to change the viewing range of a zoomed display. If the display is 2X or 4X split, only the zoomed portion on the left side of the display is affected by the change. If the display is Bottom Split or Bottom Lock, **Span** adjusts how far off the bottom the unit displays data.

Gain—allows you to control the sensitivity of the unit's receiver, which provides flexibility in what is displayed. To see more detail, increase the receiver sensitivity by selecting a higher gain. If there is too much detail or if the screen is cluttered, select a lower gain.

Target Level—adjusts which colors are used to display sonar information. A **Color Bar** appears on the right side of the screen as you adjust this setting. A higher percentage results in more strong-signal colors displayed on the sonar display. A lower percentage results in more weaker-signal colors displayed on the sonar display. This setting does not increase or decrease the unit Gain.

Whiteline—controls how the unit displays information about the bottom type (hard or soft). With Whiteline Off, the bottom return displays as red. Set Whiteline at **Normal** or **1–100%** to determine bottom hardness. See page 101 for more information.

Frequency—allows you to choose a transducer frequency. Frequency refers to the “pitch” of the sound that the transducer sends and receives.

Depth Line—adds a horizontal depth line across the display that is used to measure the depth of underwater objects. The depth of the line appears in a box on the right side of the line. Press Up or Down on the **Rocker** key to move the line on the sonar display.

Noise Reject—helps filter unwanted noise from the sonar display. The Noise Reject can be turned **Off**, set to **Normal** (automatically adjusts for optimum viewing) or to a fixed **1–100%** setting. When setting the Noise Reject, remember that a higher noise rejection setting is less likely to show fish or structures.

Resizing the Split Screen

You can adjust the way the split screen is displayed. This option is only available when a zoom scale other than **No Zoom** is selected.

To resize the Sonar page split screen:

1. From the Sonar page split screen, press **MENU**.
2. Using the **Rocker** key, highlight **Size Split**, and press **ENTER**.
3. Move the horizontal double-arrow Left or Right using the **Rocker** key until the desired vertical width line shows, then press **ENTER**.
4. If you wish to cancel this operation, press **QUIT** or press **MENU**, highlight **Stop Resizing**, and press **ENTER**.

Using the Pointer on the Sonar Page

You can display the pointer (arrow)  to reference sonar items and mark underwater waypoints. This makes it easier to find and use an object such as a stump for a future fishing location. When using this feature, the Sonar page pauses. The depth continues to update while the display is paused, but the unit does not show any new sonar data until the Sonar page resumes scrolling. You may see a discontinuity from where the sonar information stops and where it starts again.

To mark an underwater waypoint:

1. From the Sonar page, press **MENU**, highlight **Show Pointer** and press **ENTER**.
2. Use the **Rocker** key to move the cursor to the location you want to mark. Press **ENTER**. The New Map Waypoint page appears.
3. To change the name, symbol or depth, highlight the appropriate field and press **ENTER**. Make your changes and press **ENTER**.
4. When you are done making changes, highlight **OK** and press **ENTER**.
5. To return to the standard Sonar page, press **QUIT**; or press **MENU**, highlight **Hide Pointer**, and press **ENTER**.

Setting up the Sonar

Use the Setup tab in the Main Menu to set up the Sonar page. Press **MENU** two times to open the Main Menu. Select **Setup** from the vertical row of tabs on the left, then select **Sonar Setup** from the row of tabs along the top of the screen.

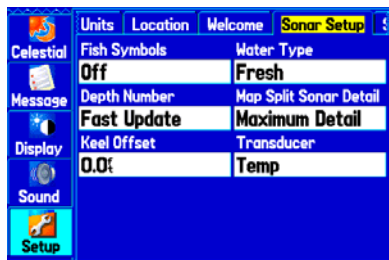

Sonar Setup Tab of the Main Menu

Fish Symbols—select how the Sonar page displays underwater targets and background information. If you select **Off**, the unit displays all of the available information about the underwater environment. If you select a fish symbol, the Sonar page displays only the information related to that symbol.

Water Type—select the proper water type you are boating in. Since sound waves travel through Fresh and Salt water at different rates, it is necessary to select the Water Type to ensure accurate readings on the unit.

Depth Number—select how efficient the digital depth update rate is. **Fast Sonar Update** updates quicker and is recommended for low-noise water deeper than 50 feet. **Auto** is best for shallow water or high-noise areas, has a slower screen update, and is best used if you travel a wide variety of depths.

If the unit is unable to track the bottom for any reason, the digits in the depth window flash on and off to alert you that the unit is not tracking the bottom.

Map Split Sonar Detail—select how much detail is displayed on the Map page with the sonar displayed. **Full Range** shows data using the **Range** setting of the Sonar page, regardless of **Zoom** or **Bottom Lock**. **Maximum Detail** shows any **Zoom** or **Bottom Lock** data from the Sonar page.

Keel Offset—enter the surface reading for the depth of a keel. This makes it possible to measure depth from the bottom of your keel instead of from the transducer's location. Enter a positive number to offset for a keel. It is also possible to enter a negative number to compensate for a large vessel that may draw several feet of water. The **Keel Offset** is reflected in the depth reading.

Transducer—select the type of transducer that you are using. If you are using a speed-capable transducer/sensor, select **Temp, Spd**.

Calibrating the Water Speed

If you select **Temp, Spd** for the **Transducer** option on the Sonar Setup tab, you also need to calibrate the water speed to ensure that the **Water Speed** displayed on your unit is accurate. The calibration should take place in water having little or no current.

The unit automatically uses the GPS ground speed, if it is available, for comparison on the calibration. If a GPS ground speed is not available, use either your boat's speedometer reading (not always accurate) or a stopwatch to determine your speed over a certain distance. To find out your speed, divide the distance by the time.

To calibrate the water speed:

1. From the Sonar Setup tab, use the **Rocker** key to highlight **Calibrate Water Speed** and press **ENTER**.
2. Bring the boat to a cruising speed. Both the top ground and uncalibrated water speeds is shown at the bottom of the calibration window. Note your top speed, then stop the boat and press **ENTER**.

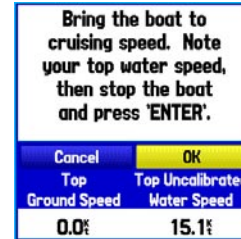

Calibrating the Water Speed

3. By default, the top ground speed is automatically shown. If a ground speed is not available, the top uncalibrated water speed is used instead. If the new speed is correct, highlight **OK** and press **ENTER**.

If you wish to manually enter a calibration, press **ENTER** while the speed is highlighted, enter a new speed, and press **ENTER**.

If the boat is not moving fast enough or the speed sensor is not outputting a speed, "Boat Is Not Moving Fast Enough To Calibrate" displays at the bottom of the screen. Check that the speed sensor wheel is moving or safely increase boat speed. If there is a problem with the speed sensor or if a speed sensor is not installed, "Water Speed Sensor Is Not Working" appears at the bottom of the display. Check connections of speed sensor cables.

Setting up the Sonar Display

You can set up how the sonar information is displayed on the screen. Press **MENU** two times to open the Main Menu. Select **Setup** from the vertical row of tabs on the left, then select **Sonar Display** from the row of tabs along the top of the screen.

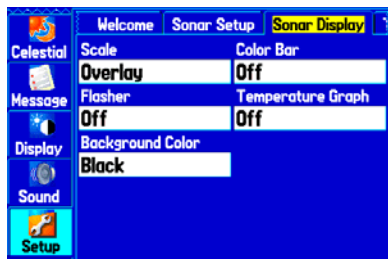

Sonar Display Setup Tab

Scale—select how and where you want the depth scale to be displayed.

Color Bar—select **On** to show a gradient scale of the current Target Level setting on the Sonar Setup tab.

Flasher—select **On** to display a graphic Flasher representation on the far right side of the sonar display. This graphic Flasher displays structure and bottom returns much the same as a true Flasher. You may find this feature particularly useful when using Fish Symbols.

Temperature Graph—select **On** to display a temperature graph along the bottom of the Sonar page.

Background Color—select the color for the Sonar page and the sonar on the Map split.

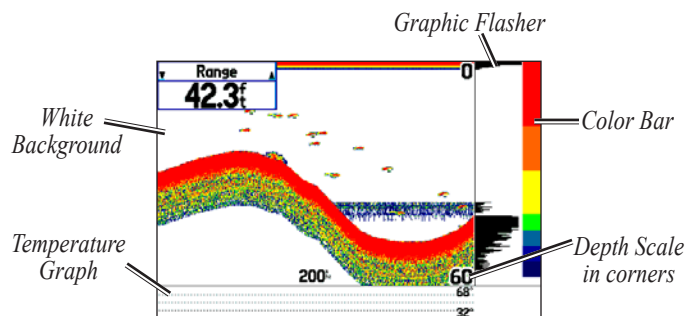

Sonar Page with the Sonar Display settings changed

Understanding Sonar

The transducer mounted on your vessel transmits sound waves toward the bottom of the water in a cone-shaped pattern. When a transmitted sound wave strikes an underwater object—such as the bottom, a structure, or a fish—sound is reflected back to the transducer. The transducer collects the reflected sound waves and sends the data to the GSD 20 Sounder Module and then to the GPSMAP 276C to be processed and displayed. The underwater data is shown on the Sonar display in the order that it is returned; first returned is the first on the display.

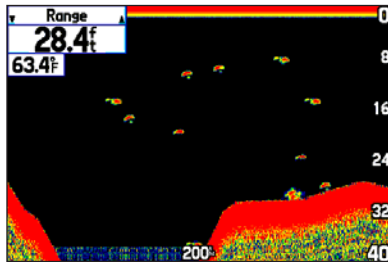

Sonar Page

Generally speaking, if the only thing between the transducer and the bottom is water, the first strong return comes from the bottom directly below the transducer and sets the bottom level. Weaker secondary returns provide the detailed data. Stronger returns display in darker colors, with red being the strongest return.

Understanding the Sonar Display

One of the first things to understand about sonar is that the transducer sends a beam down to the bottom of the water, much like the beam of a flashlight. The beam starts small near your vessel and expands as it gets to the bottom. Refer to “Transducer Coverage” for more detailed information.

The Sonar page does not display a three-dimensional representation of the underwater environment; the display is in two-dimensions, much like if you took a picture of an aquarium. Only the depth of the item in the water is displayed. The Sonar display does not show you where an item is located horizontally in the water, as shown in the drawings below. The fish is not directly above the tree in reality, but it may look like it is on the Sonar page.

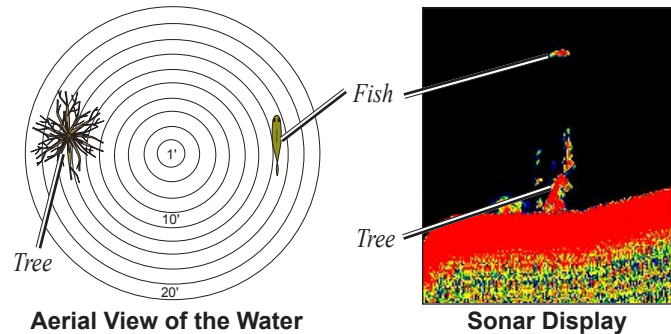

Aerial View of the Water

Sonar Display

Transducer Coverage

The area covered by the transmitted sound waves is determined by the cone angle of the transducer and the water depth. The wide cone angles (40°) associated with low frequencies (50 kHz) provide a large coverage area for finding fish within a coverage width that is approximately $2/3$ of the water depth. However, this also means that wide cone angles produce less bottom detail and resolution. As shown in the drawing on the near right, the 40° cone angle produces a coverage area of approximately a 20-foot diameter circle at a 30-foot depth.

The narrow cone angles (10°) associated with high frequencies (200 kHz) provide better bottom resolution and crisper detail, but cannot show a large coverage area for finding fish. The 10° cone angle provides a coverage width that is approximately $2/10$ of the water depth. As shown in the drawing on the far right, the 10° cone angle produces a coverage area of approximately a 6-foot diameter circle at a 30-foot depth.

Dual frequency mode combines both frequencies to get the best coverage area and contour/depth readings.

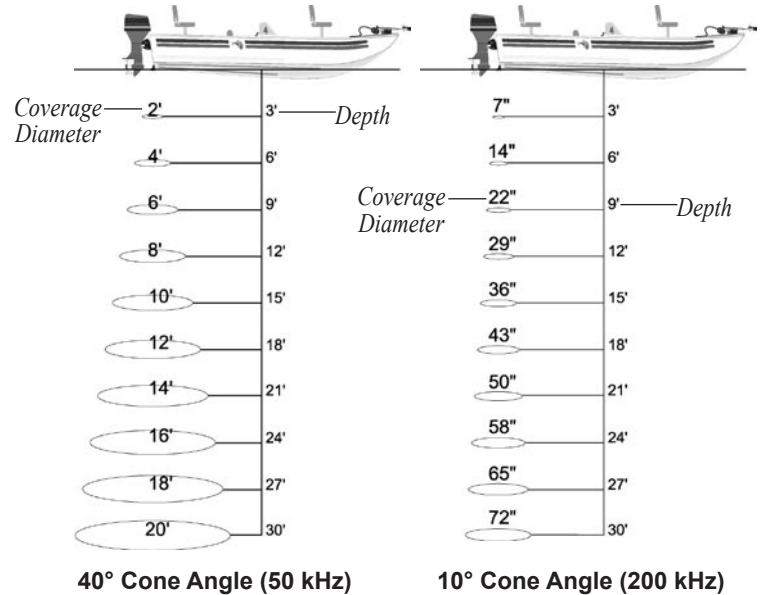

Whiteline

The GSD 20 Sounder Module can help you determine whether the bottom is hard or soft. When the sonar sound waves are reflected back by the bottom, a hard bottom returns a stronger signal than a soft bottom. A thin whiteline indicates a softer bottom, while a thick whiteline indicates a harder bottom. Normally, a red line is used to show the point where water meets the bottom. This line follows the bottom contour, along with any significant objects lying on the bottom. The unit uses the whiteline function to make the bottom layer information easier to distinguish.

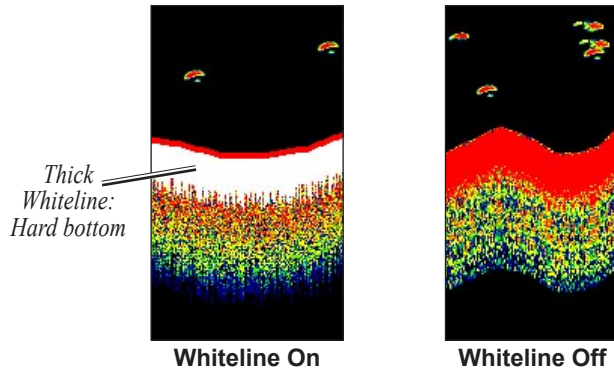

Thermoclines

A rough definition of a thermocline is a break in water where the water temperature changes faster than the water above it. Thermoclines are shown as the weakest colors.

One of the unique features offered by Garmin is See-Thru[®] technology, which allows the GPSMAP 276C to hear both weak and strong signals simultaneously so it can identify fish returns under the toughest conditions, such as suspended in thermoclines or even hiding near structures. See-Thru technology allows the GSD 20 Sounder Module to “see” through thermoclines and helps locate fish where they live—and fish love thermoclines!

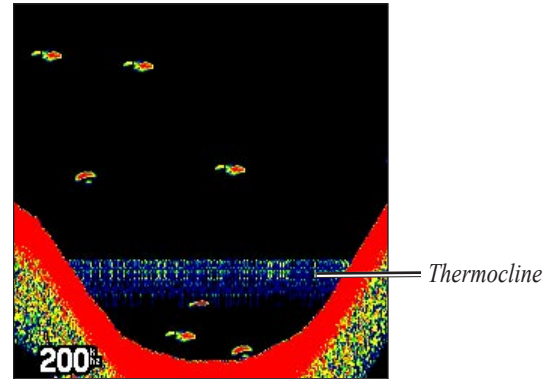

APPENDIX

Specifications

Physical Specifications

Size:	5.7" W x 3.2" H x 1.9" D (14.5 x 8.1 x 4.8 cm)
Weight:	13.6 oz (0.39 kg)
Display:	3.75" diagonal (9.5 cm) Transflective, 256-color display with backlighting (480 x 320 pixels)
Case:	Fully gasketed, high-impact plastic alloy, waterproof to IEC 60529 IPX7
Temp. Range:	5°F to 140°F (-15°C to 60°C)

Power

Battery:	Rechargeable lithium-ion
Battery Life:	5 to 15 hours depending upon the backlight setting
Source:	11–35 VDC
Fuse:	3AG - 1.5 Amp

Performance

Receiver:	Differential-ready 12 parallel channel receiver
Acquisition Times:	Approx. 15 seconds (warm start) Approx. 45 seconds (cold start) Approx. 5 minutes (First Time/AutoLocate™)
Update Rate:	1/second, continuous

Accuracy

GPS:	15 meters (49 feet) RMS 95% typical
DGPS (USCG):	3–5 meters (10–16 ft), 95% typical
DGPS (WAAS):	< 3 meters (10 ft) 95% typical with DGPS corrections
Velocity:	0.1 knot RMS steady state
Dynamics:	6 g's

Optional Accessories

In addition to the standard accessories included with your GPSMAP 276C, several optional accessories are available to enhance the operation of the GPSMAP 276C.

To obtain replacement parts and optional accessories, contact your Garmin Dealer, Garmin Product Support in the U.S.A. at 800/800.1020, or Garmin Europe at 44/0870.8501241.



WARNING: *Garmin accessories have been designed and specifically tested for use with Garmin products. Accessories offered by other manufacturers have not been tested or approved for use with Garmin products. Use of such accessories could cause damage to the GPSMAP 276C and void the warranty.*

Auto Navigation Kit: Provides the parts and map data to use the GPSMAP 276C in an automobile.

GA 29, GA 29F, and GA 26C Antennas: Garmin remote antennas.

Non-Skid Friction Mount: Portable vehicle mount, no installation required.

Permanent and Temporary Adhesive Disks: Adhesive disks for using the unit in a vehicle.

External Speaker with 12/24-Volt Adapter Cable: Allows the unit to operate from the vehicle's power system through the cigarette lighter adapter. Provides a speaker for vocal prompts.

GPSMAP 276C Owner's Manual

PC Interface Cable: Connects the unit to a serial port on your PC.

Power/Data Cable: Allows you to connect the unit to the electrical system using bare wires.

Programmable Data Cards: Blank data cards available in 8 MB, 16 MB, 32 MB, 64 MB, and 128 MB sizes. Download detailed map data from MapSource CD-ROMs to a data card, either directly through your GPSMAP 276C using the PC USB Cable, the optional PC Interface Cable, or with the optional USB Data Card Programmer.

USB Data Card Programmer: Programs blank data cards at high speed through a PC.

Carrying Case: Protects the GPSMAP 276C when not in use; has storage space for data cards.

Protective Cover: Snaps on the front of the unit to protect the screen from damage.

MapSource Software CD-ROMs: Offers several detailed mapping options that are compatible with the GPSMAP 276C, including City Select, BlueChart, Fishing Hot Spots, and Topo.

Pre-Programmed Data Cards: Data cards pre-programmed with either Garmin BlueChart or Fishing Hot Spots map data.

Installation Information

This section of the Appendix provides information on connecting the GPSMAP 276C to auxiliary devices and removing the antenna.

Connecting the Power/Data Cable

The power/data cable connects the GPSMAP 276C to an 11–35 VDC system and provides interface capabilities for connecting external devices. The color code in the diagram below and to the right indicates the appropriate harness connections. Replacement fuse is a 3AG - 1.5 Amp fuse.

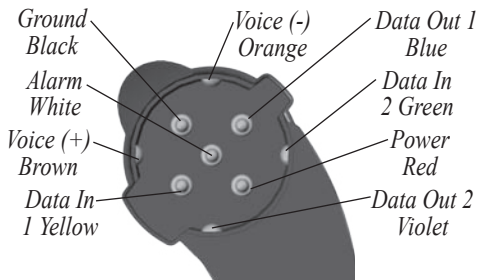

Power/Data Connector on the GPSMAP 276C Unit

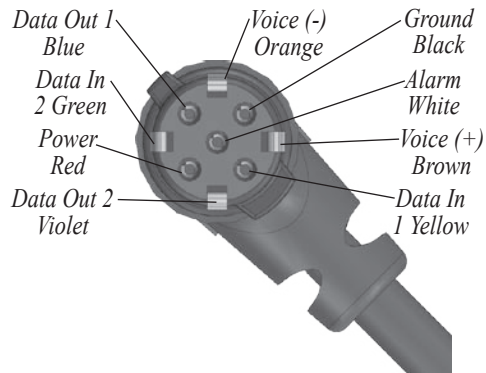

Power/Data Connector on the Cable

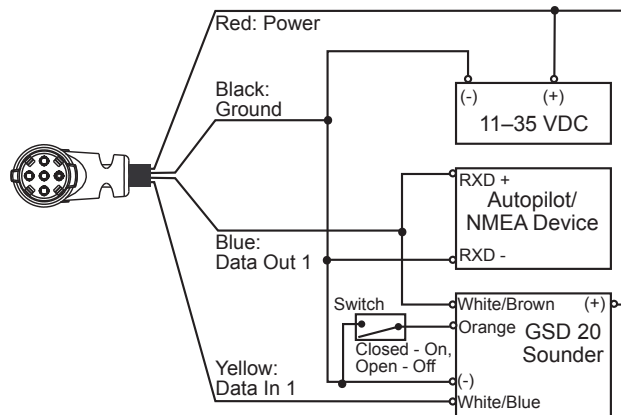

Connecting Your GPSMAP 276C to a Computer

Your GPSMAP 276C can be connected to your computer using the supplied USB cable to connect to a USB data port or the optional PC Interface Cable to connect to a DB-9 serial communications port.



NOTE: Fully install the supplied MapSource program, Trip & Waypoint Manager, on your computer before connecting the USB cable to the computer.



USB
connector
under
weather cap

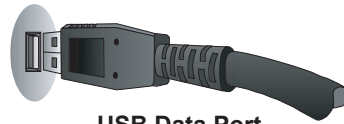

USB Data Port

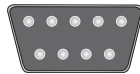

Serial Communications Port

To connect your GPS to your computer:

1. Connect the small end of your cable to the lower connector on the back of the GPSMAP 276C, shown in the illustration to the left.
2. When using the supplied USB Data Cable, connect the larger end of the cable to an available USB data port (see illustration on the left).

When using a PC Interface Cable, connect the larger end of the cable to a serial communications port on your computer (see illustration on the bottom left).

Information about USB Drivers

The USB drivers should have been automatically installed when you installed the MapSource program that came with your GPSMAP 276C. When you initially connect the GPSMAP 276C to a USB port, your computer may prompt you to locate the destination of the drivers for the device. You only need to install the drivers once. After the drivers are installed, your computer will always detect your GPSMAP 276C when it is connected. USB drivers may be updated periodically. You can find these updates at www.garmin.com.

Using xImage for Customized Waypoint Icons

xImage allows you to exchange images between your PC and your GPSMAP 276C. You can download and save screen shots of any screen displayed on your unit. xImage also allows you to download customizable splash screens and waypoint symbols from compatible GPS units, customize them (if you have an image editing program on your PC), and send them back to your GPS unit.

You can download xImage from the Garmin Web site at <http://www.garmin.com/ximage/>. Refer to the help file for complete instructions about using xImage.

Installing and Removing Data Cards

The GPSMAP 276C uses an optional Garmin data card to display digital charts and maps or save user data. Install the data card in the card slot located on the bottom of the unit. Install or remove the data card at any time, whether the unit is on or off.

You can load a variety of information on your data card, such as BlueChart and MapSource detailed maps, and waypoint, route, and track information saved in a MapSource program. You can also buy pre-programmed cards to use with your GPSMAP 276C.

Data cards are not waterproof, should not be exposed to moisture or excessive static charges, and should be stored in the case supplied with the card.

To install a data card:

1. Insert the card into the slot on the bottom of the unit. Be sure the label is facing the front of the unit.
2. Firmly push the card into the unit. It is not necessary to force the card. The handle is still exposed when it is properly inserted.
3. If the unit is on, a confirmation tone sounds. The first time you insert a programmed data card, the unit takes a few seconds to read the card. Once the data card has been properly installed and accepted, a summary screen noting the card details appears. Press **ENTER** to acknowledge.

If you insert a data card and get a card format not recognized message, try removing the card and reinserting it. If the card is still not recognized, contact Garmin or your Garmin dealer.

To remove a data card:

1. Grasp the card handle. The handle expands for easy removal.
2. Pull the card out of the card slot on the bottom of the unit.
3. If the unit is on, a confirmation tone sounds when the data card has been removed.

Interfacing

The following formats are supported for connection of external devices: GARMIN proprietary Differential GPS (DGPS), NMEA 0180, 0182, 0183 (versions 1.5, 2.0, 2.3, 3.01), ASCII Text Output, and RTCM SC-104 input (version 2.0).

The following are the Approved Sentences for NMEA 0183, version 3.01 output: GPRMC, GPGGA, GPGSA, GPGSV, GPGLL, GPBOD, GPRTE, and GPWPL. The following are the Proprietary Sentences for NMEA 0183, version 3.01 output: PGRME, PGRMZ, and PGRMM.

The GPSMAP 276C also includes NMEA input with support for the BWC, DBT, DPT, MTW, VHW, VTG, and XTE sentences.

Garmin's proprietary communication protocol is available from the Web site (www.garmin.com).

Removing the Antenna

You can remove the antenna to use an external antenna. After the antenna is removed, the BNC connector is exposed and ready for use with an external antenna. For information on connecting an external antenna to the GPSMAP 276C, refer to the installation instructions that came with the antenna.

To remove the antenna:

1. Remove the external power cable from the connector on the back of the GPSMAP 276C.
2. Rotate the antenna to approximately a seven o'clock position. The alignment notches in the casing must line up with the notches on the antenna.
3. Pull the antenna away from the GPSMAP 276C unit.

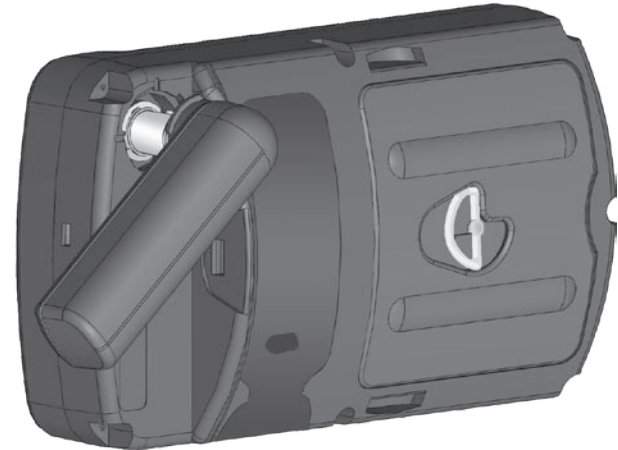

Removing the Antenna

Learning about GPS

The Global Positioning System (GPS) is a satellite-based navigation system made up of a network of 24 satellites placed into orbit by the United States Department of Defense.

GPS was originally intended for military applications, but in the 1980s, the government made the system available for civilian use. GPS works in any weather conditions, anywhere in the world, 24 hours a day. There are no subscription fees or setup charges to use GPS. For more information refer to the Garmin Web site at www.garmin.com and also read the *GPS Guide for Beginners*, which can be found on the Web site at <http://www.garmin.com/aboutGPS/manual.html>.

Common GPS Terms

Initialization—the first time a GPS receiver orients itself to its current location and collects data. After the receiver is initialized, it remembers its location and acquires a position more quickly.

Position—an exact, unique location based on geographic coordinates (Latitude and Longitude).

Route—A group of waypoints entered into the GPS receiver in the sequence you desire to navigate them.

Waypoint—a location you store in your GPS. It may be a checkpoint on a route or a significant ground feature, such as your campsite or favorite fishing spot.

What is Differential GPS (DGPS)?

The United States and Canadian governments (among others) have set up Differential GPS (DGPS) stations to transmit correction signals. They are operational in coastal areas and on many navigable river systems.

The DGPS system is available for use without a fee, but you do need additional equipment to receive DGPS signals; a beacon receiver compatible with the RTCM format sentences supported by your Garmin GPS is needed to use DGPS.

Refer to the United States Coast Guard's Web site (<http://www.navcen.uscg.gov/>) for locations and status of the differential stations.

Differential Field

Differential receiver status is indicated in the bottom left field of the GPS page and will show one of the following conditions:

- **None:** No optional beacon receiver is attached or enabled in the Com 1 or 2 tab of the Main Menu or WAAS is turned Off.
- **Searching for WAAS:** WAAS is enabled and the receiver is searching for WAAS signal.

- **Using WAAS:** WAAS capability is enabled and the unit is receiving WAAS corrections.
- **Check Beacon Wiring:** The DGPS setting is enabled in the Com 1 or 2 tab of the Main Menu but no DGPS device is detected.
- **No Beacon Signal:** DGPS receiver is attached, but not transmitting RTCM data to GPS.
- **Tuning Beacon:** The receiver is tuning manually to a DGPS frequency.
- **Using Differential:** The unit is receiving DGPS corrections.
- **Scanning for Beacon:** The DGPS receiver is scanning for an available frequency.

What is WAAS?

The Wide Area Augmentation System (WAAS) is an FAA-funded project to improve the overall integrity of the GPS signal and increase position accuracy for users in North America.

The system is made up of satellites and approximately twenty-five ground reference stations positioned across the United States that monitor GPS satellite data. Two master stations, located on either coast, collect data from the reference stations and create a GPS data correction message.

According to the FAA's Web site, testing in September 2002 of WAAS confirmed an accuracy performance of 1–2 meters horizontal and 2–3 meters vertical throughout the majority of the continental United States and portions of Alaska.

WAAS is just one service provider that adheres to the MOPS (Minimum Operational Performance Standard) for global Satellite Based Augmentation Systems (SBAS). Eventually, there will be several services of worldwide geostationary communication satellites and ground reference stations.

All SBAS systems use the same receiver frequency; therefore, any operational SBAS system should be capable of providing your GPS unit with increased accuracy at any location in the world.

Currently, enabling WAAS on your Garmin GPSMAP 276C in regions that are not supported by ground stations may not improve accuracy, even when receiving signals from an SBAS satellite. In fact it can degrade the accuracy to less than that provided by GPS satellites alone. For this reason, when you enable WAAS on your Garmin GPS receiver, the receiver automatically uses the method that achieves the best accuracy. To enable WAAS, refer to page 6.

For more information, go to <http://gps.faa.gov/Programs/WAAS/waas.htm>.

LORAN TD Setup

LORAN C is a radio navigation aid operated and maintained in the United States by the United States Coast Guard. The name LORAN is an acronym for “LOng RANGE Navigation.” The LORAN system covers the entire United States and the United States Coastal Confluence Zone. From the perspective of a mariner, the system is used for ocean and coastal navigation. It can be used as a supplemental system for harbor and harbor approach navigation, and it is used for inland navigation by recreational vehicles.

LORAN TD Feature

The LORAN TD (Time Delay) feature eases the transition from using LORAN to using GPS. The GPSMAP unit automatically converts GPS coordinates to LORAN TDs for those who have a collection of LORAN fixes for favorite fishing spots and other waypoints recorded as TDs. You can display your position as a TD or enter waypoints as TDs. The accuracy to be expected from this conversion is approximately thirty (30) meters. When the unit is placed in the LORAN TD format mode, it simulates the operation of a LORAN receiver. Position coordinates may be displayed as TDs, and all navigation functions may be used as if the unit was actually receiving LORAN signals.

Using the LORAN TD Format

When creating new waypoints using LORAN TD coordinates, you must set the correct LORAN chain number and secondary stations in the Setup TD field before storing the waypoint. After the waypoint is stored in unit memory, it will always reference the LORAN chain number and secondary stations currently selected in the Setup TD field. If you enter a different LORAN chain number or change the secondary stations or offsets in the Setup TD field, the active waypoint information will reflect those changes. Since the GPSMAP 276C does not rely on the LORAN signal for navigation, it can reference a different GRI chain and/or secondary stations and still navigate to the location stored in memory.

The LORAN Position Format field is located under the Units tab in the Main Menu. The LORAN TD Setup window contains the fields to select the Loran GRI-Chain Number, Primary and Secondary Stations, and TD Offsets.

To set up Loran TD from the Main Menu:

1. Press **MENU** twice to display the Main Menu.
2. Use the **Rocker** key to highlight Setup on the vertical tab list. Then select **Location** from the row of horizontal tabs.
2. Using the **Rocker** key, highlight the **Location Format** field and press **ENTER**.

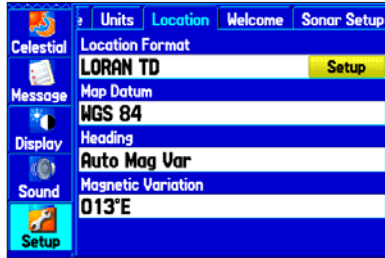

Location Tab of the Setup Tab

3. Highlight **Loran TD** press **ENTER**.
4. Highlight the **Setup** button located on the right side of the **Location Format** field and press **ENTER**. The Loran TD Setup window appears.
5. To change the settings of any of the five fields, highlight the field, press **ENTER**, enter the desired setting using the **Rocker** key, then press **ENTER**.



LORAN TD Setup

6. When done, highlight the **Save** button and press **ENTER**.
If the active GRI Chain, secondary stations, or offsets have been changed since the waypoint was created, the waypoint will now reference the active GRI chain and secondary stations and adjust the TD coordinates accordingly. Remember that the GPS is not relying on the LORAN signal for navigation and actually converts the TD coordinate to a useful latitude and longitude coordinate before storing the waypoint to memory or using it for navigation. Because of this, the unit can navigate to a TD coordinate anywhere in the world.

You must know your GRI chain number and secondary stations to create a LORAN TD position. For more information, read our *LORAN TD Position Format Handbook*, available at the Garmin Web site, at www.garmin.com/support/userManual.html.

Map Datums and Location Formats

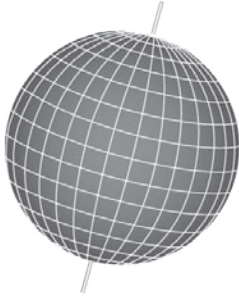

Map Datums are based on a mathematical model of the Earth.

What are a Map Datum and which should I use?

A datum is a mathematical model of the Earth that approximates the shape of the Earth and enables calculations to be carried out in a consistent and accurate manner. The datum is physically represented by a framework of ground monuments whose positions have been accurately measured and calculated on this reference surface. Lines of latitude and longitude on a map or chart are referenced to a specific map datum. Every chart has a map datum reference, and you can set the GPSMAP 276C to match most of those commonly used.

If you are navigating and comparing the GPS coordinates to a map, chart, or other reference, set the map datum in the GPS unit to the same datum as the map to ensure the most accurate navigation.

What is a Location Format and which should I use?

Your current location can be viewed on the GPS in the form of coordinates. Since different maps and charts use different location formats, Garmin GPS units allow you to choose the correct coordinate system for the type of map you are using. The most common format is latitude and longitude, which is utilized by all Garmin units.

You may choose to change the location format to use with other coordinate systems in Location field of the Location Setup tab. UTM/UPS (Universal Transverse Mercator/Universal Polar Stereographic) are easy-to-use metric grids that are found on most USGS topographic quadrangle maps. You can also select one of several other grids, including a user-definable grid (for the advanced user).

For more information about using paper maps with your Garmin unit, refer to *Using a Garmin GPS with Paper Land Maps*, available for download at http://www.garmin.com/manuals/UsingaGarminGPSwithPaperLandMaps_Manual.pdf.

Digital Selective Calling (DSC)

Digital Selective Calling (DSC) uses marine VHF radio and Global Positioning System (GPS) technologies to transmit and receive location information. DSC is used by mariners to assist them in two major areas: Distress Calls and Position Reporting.

A non-emergency DSC Position Report allows mariners to exchange and display their positions. When you receive a DSC position, you can create a waypoint or to show the received position on an electronic map.

An emergency DSC Distress Call allows a vessel in trouble to transmit a substantial amount of information in a single transmission, or “call,” without the need for voice communication. When any nearby rescuer receives the DSC signal, an alarm sounds, and they immediately receive the position of the caller.

The rescuer may then choose to navigate (Go To) the caller’s position to assist or forward the call on to the Coast Guard. When the Coast Guard receives the call, they can immediately access the caller’s information (such as who they are and the type of vessel) in their database while they are in transit to the caller’s position.

Any time a vessel receives a DSC call, they can store that location and quickly navigate to that position using a Go To. This makes DSC a time-saver, especially in an emergency situation. In order to

use DSC, users must first register their VHF radio with the FCC and receive a Maritime Mobile Service Identity (MMSI) number.

What is a Maritime Mobile Service Identity (MMSI) number?

Maritime Mobile Service Identity (MMSI) basically allows a VHF radio to act like a phone. The 9-digit MMSI number acts like a phone number when used in a Position Report and as a unique identifier to the Coast Guard when used in an emergency Distress Call. To obtain a Maritime Mobile Service Identity (MMSI) number, users must register their VHF radio with the FCC (Form 605).

Garmin does not supply this number!

For more information regarding MMSI numbers, visit <http://www.navcen.uscg.gov/marcomms/gmdss/mmsi.htm>.

How are MMSI assignments obtained?

Non-commercial users, such as recreational users, who remain in United States waters and only carry VHF, EPIRB (Emergency Position Indicating Radio Beacons), and Radar are not required to have a FCC ship station license. The FCC and Coast Guard have authorized some second and third party vendors to assign MMSI numbers. This service is limited to registering recreational vessels only. To receive information on how to obtain a recreational MMSI number, contact <http://www.uscg.mil/rescue21/links/mmsi.htm> or <http://wireless.fcc.gov/marine/>.

Non-Federal Users in the United States

Commercial users, or those who travel outside the United States or Canada, must apply for a ship station license or an amendment to a ship station license. To find out if you require a Ship Station license, contact <http://wireless.fcc.gov/marine/fctsht14.html>. If your vessel requires licensing by the FCC, you will obtain a MMSI during the application/licensing process when you file FCC Forms 159 and 605.

Federal Users in the United States

Federal users can obtain MMSI assignments from their agency radio spectrum management office. These procedures are currently under review by the National Telecommunications and Information Administration (NTIA).

Users Outside the United States

Users can obtain an MMSI assignment from their telecommunications authority or ship registry, often by obtaining or amending their ship station license.

Users In Canada

Industry Canada is responsible for assigning MMSI numbers to commercial and recreational vessels. Information is available at the following Web site: <http://apollo.ic.gc.ca/english/mmsi.html>.

How can Garmin help you with DSC?

To receive Distress Calls or Position Reports, you must have a DSC-equipped chartplotter as well as a VHF radio with DSC support. During normal, non-emergency Position Report communication, Channel 70 (156.525 MHz) has been set aside as the VHF/DSC digital call channel.

For a Distress Call, press the MayDay button on the VHF radio. The call transmits on an emergency channel with the MMSI number attached to the call, if the receiver has DSC support. Any DSC-equipped mariner (on sea or land) within range can receive the call.

When the GPSMAP 276C is connected to a VHF with DSC support, the GPS unit displays a Call List, Log, and a Directory. Basic wiring is required for the Garmin unit and VHF radio to send and receive NMEA data from each other.

Messages

Approaching Turn: You are nearing a turn in a route.

Arriving at Destination: You are nearing your destination.

Batteries Low: The battery needs to be recharged.

Can't Unlock Maps: No applicable unlock code for one or more maps was found. All MapSource maps are not accessible.

Database Error: Internal problem with the unit. Contact your dealer or Garmin Product Support to have the unit repaired.

Deep Water: The water is deeper than the amount set in the Deep Water Alarm.

Dragging Anchor: The distance set in the Anchor Drag Alarm is exceeded.

Lost Satellite Reception: The unit is unable to receive satellite signals.

Memory Full: Unit memory is full, no further data can be saved.

Near Proximity Point: You have reached the distance set for a proximity waypoint.

No Diff GPS Location: RTCM is selected but the unit is not receiving DGPS data.

None Found: No data matched the search criteria.

No Tide Stations for that Area: No tide stations within 100 miles of the area.

Off Course: You are off course by the distance set in the Off Course Alarm.

Proximity Memory Full: No additional proximity waypoints can be saved.

Proximity Radius Overlaps: The radius of two proximity waypoints overlap.

Route Already Exists: You have entered a route name that already exists.

Route Memory Full: No additional routes can be saved.

Route Truncated: Uploaded route from another device has more than 50 waypoints.

Route Waypoint Memory Full: No additional route waypoints can be saved.

Shallow Water: The water is shallower than the amount set in the Shallow Water Alarm.

Track Already Exists: A saved track with the same name already exists.

Track Log Full: The track log is full and track recording has been turned off. In order to record more track points, you will need to clear the track log and turn track recording on.

Track Memory Full: No more track data can be stored. Delete the old track data to store the new data.

Track Truncated: A complete uploaded track will not fit in memory. The oldest track log points have been deleted.

Transfer Complete: Data transfer has been completed.

Waypoint Already Exists: A waypoint with the same name already exists.

Waypoint Memory Full: The unit has stored the maximum number of waypoints.

Data Field Options

The following list provides a brief description of each data field option. Some of these options are supported only by devices interfaced to your GPSMAP 276C.

Accuracy: The current accuracy of your GPS determined location.

Battery Timer: The time remaining on the battery before it is fully discharged.

Bearing: The compass direction from your current location to a destination.

Course: The desired path of travel from your starting location to a destination.

Course to Steer: The recommended direction to steer in order to reduce cross-track error and return to the course line. Displayed as **Steer**.

Cross Track: The distance you are off a desired course in either direction, left or right.

Depth: (Marine Only) The depth of water from sonar NMEA input.

Dest Wpt: See **Waypoint (Destination)** on the next page.

Distance (Destination): The entire distance, from beginning to end, of a route.

Distance (Next): The distance to the next point on a route.

ETA (Destination): Estimated Time of Arrival. The estimated time you will reach your destination.

ETA (Next): Estimated Time of Arrival. The estimated time you will reach the next point on your route.

ETE (Destination): Estimated Time Enroute. The estimated time required to reach your destination.

ETE (Next): Estimated Time Enroute. The estimated time required to reach the next point on your route.

Elevation: The altitude (height) above or below mean sea level (MSL).

GPS Status: The current status of the GPS receiver, such as “3D GPS.”

Location (Lat/Lon): Your current location as latitude/longitude coordinates.

Location (Selected): Your current location described in the selected units of measure (other than lat/lon).

Max Speed: The maximum speed the unit has moved since last reset.

Mov Avg Spd: See **Trip Avg. Speed (Moving)** on the next page.

Move Timer: See **Trip Timer (Moving)** on the next page.

Next Course: The remaining distance of the route.

Next Turn: The remaining distance to the next waypoint on the route.

Next Wpt: See **Waypoint (Next)** on the next page.

Odometer: The total distance traveled since the Odometer was reset.

Pointer: The arrow indicating the direction to travel to the next point on a route.

Power: The power indicator icon: Battery, External Power, or Charging.

Speed: Your current vehicle speed can be measured in miles per hour, kilometers per hour, or knots.

Steer: See **Course to Steer** on the previous page.

Sunrise: The time at which the sun rises on this day.

Sunset: The time at which the sun sets on this day.

Time: The current time and date. It can be displayed in 12-hour or 24-hour format in local time or universal (UTC) time.

Time to VNAV: See **Est. Time to VNAV** on the previous page.

Track: The direction of movement relative to a ground position. Also referred to as ground track.

Trip Avg. Speed (Moving): The average speed while moving since the last reset of the Trip Computer. Displayed as **Mov Avg Spd**.

Trip Avg. Speed (Total): The total average speed traveled since the last reset of the Trip Computer. Displayed as **Ttl Avg Spd**.

Trip Odometer: The total distance traveled since the Trip Computer was reset.

Trip Timer (Moving): The length of time your vehicle has been in motion, since the Trip Computer was reset. Displayed as **Move Timer**.

Trip Timer (Total): The total time the unit has been tracking since the Trip Computer was reset.

Ttl Avg Spd: See **Trip Avg. Speed (Total)**.

Turn: The direction of, and distance to, the next turn on an active route.

User Timer: The timer you set in the Main Menu.

Velocity Made Good: The rate of closure on a destination based upon your current speed and course of travel. Displayed as **VMG**.

Vertical Speed: The rate of climb or descent.

Voltage: The direct current voltage level of an external power source.

Water Speed: (Marine Only) The data acquired from measurement devices interfaced to the unit is used to calculate your current speed over water.

Water Temperature: (Marine Only) The temperature of water at a measured depth using measurement devices interfaced to the unit.

Waypoint (Destination): The last point on a route, your destination. Displayed as **Dest Wpt**.

Waypoint (Next): The next waypoint in your route. Displayed as **Next Wpt**.

Safety and Product Information

This section of the Appendix contains information about your license agreement and warranty, as well as compliance information. Read the Safety Information to learn how to properly and safely operate the GPSMAP 276C.

Software License Agreement

BY USING THE GPSMAP 276C, YOU AGREE TO BE BOUND BY THE TERMS AND CONDITIONS OF THE FOLLOWING SOFTWARE LICENSE AGREEMENT. PLEASE READ THIS AGREEMENT CAREFULLY.

Garmin grants you a limited license to use the software embedded in this device (the “Software”) in binary executable form in the normal operation of the product. Title, ownership rights, and intellectual property rights in and to the Software remain with Garmin.

You acknowledge that the Software is the property of Garmin and is protected under the United States of America copyright laws and international copyright treaties. You further acknowledge that the structure, organization, and code of the Software are valuable trade secrets of Garmin and that the Software in source code form remains a valuable trade secret of Garmin. You agree not to decompile, disassemble, modify, reverse assemble, reverse engineer, or reduce to human readable form the Software or any part thereof or create any derivative works based on the Software. You agree not to export or re-export the Software to any country in violation of the export control laws of the United States of America.

Product Registration

Help us better support you by completing our online registration today! Have the serial number of your GPSMAP 276C handy and connect to our Web site (www.garmin.com). Look for the Product Registration link on our Home page.

Use this area to record the serial number (8-digit number located on the back of the box) in case your GPSMAP 276C is lost, stolen, or needs service. Keep your original sales receipt in a safe place or attach a photocopy inside the manual.

Serial Number: _____

Contact Garmin

If you should encounter any difficulty while using your GPS unit, or if you have any questions, in the U.S.A. contact Garmin Product Support by phone: 913/397.8200 or 800/800.1020, Monday–Friday, 8 AM–5 PM Central Time; or by e-mail at sales@garmin.com. In Europe, contact Garmin (Europe) Ltd. at 44/0870.8501241.

Limited Warranty

This Garmin product is warranted to be free from defects in materials or workmanship for one year from the date of purchase. Within this period, Garmin will at its sole option repair or replace any components that fail in normal use. Such repairs or replacement will be made at no charge to the customer for parts or labor, provided that the customer shall be responsible for any transportation cost. This warranty does not cover failures due to abuse, misuse, accident, or unauthorized alteration or repairs.

THE WARRANTIES AND REMEDIES CONTAINED HEREIN ARE EXCLUSIVE AND IN LIEU OF ALL OTHER WARRANTIES EXPRESS OR IMPLIED OR STATUTORY, INCLUDING ANY LIABILITY ARISING UNDER ANY WARRANTY OF MERCHANTABILITY OR FITNESS FOR A PARTICULAR PURPOSE, STATUTORY OR OTHERWISE. THIS WARRANTY GIVES YOU SPECIFIC LEGAL RIGHTS, WHICH MAY VARY FROM STATE TO STATE.

IN NO EVENT SHALL GARMIN BE LIABLE FOR ANY INCIDENTAL, SPECIAL, INDIRECT OR CONSEQUENTIAL DAMAGES, WHETHER RESULTING FROM THE USE, MISUSE, OR INABILITY TO USE THIS PRODUCT OR FROM DEFECTS IN THE PRODUCT. Some states do not allow the exclusion of incidental or consequential damages, so the above limitations may not apply to you.

Garmin retains the exclusive right to repair or replace the unit or software or offer a full refund of the purchase price at its sole discretion. SUCH REMEDY SHALL BE YOUR SOLE AND EXCLUSIVE REMEDY FOR ANY BREACH OF WARRANTY.

Products sold through online auctions are not eligible for rebates or other special offers from Garmin. Online auction confirmations are not accepted for warranty verification. To obtain warranty service, an original or copy of the sales receipt from the original retailer is required. Garmin will not replace missing components from any package purchased through an online auction.

To obtain warranty service, contact your local Garmin authorized dealer or call Garmin Product Support for shipping instructions and an RMA tracking number. The unit should be securely packed with the tracking number clearly written on the outside of the package. The unit should then be sent, freight charges prepaid, to any Garmin warranty service station. A copy of the original sales receipt is required as the proof of purchase for warranty repairs.

Garmin International, Inc.

1200 E 151st Street, Olathe, Kansas 66062 U.S.A.

Tel. 913/397.8200

Fax. 913/397.8282

Garmin (Europe) Ltd.

Unit 5, The Quadrangle, Abbey Park Industrial Estate,

Romsey, SO51 9DL U.K.

Tel. 44/0870.8501241

Fax 44/0870.8501251

The Garmin GPSMAP 276C has no user-serviceable parts. Should you ever encounter a problem with your unit, take it to an authorized Garmin dealer for repairs.

The GPSMAP 276C is fastened shut with screws. Any attempt to open the case to change or modify the unit in any way will void your warranty and may result in permanent damage to the equipment.

FCC Compliance

The GPSMAP 276C complies with Part 15 of the FCC interference limits for Class B digital devices FOR HOME OR OFFICE USE. These limits are designed to provide more reasonable protection against harmful interference in a residential installation, and are more stringent than “outdoor” requirements.

Operation of this device is subject to the following conditions: (1) This device may not cause harmful interference, and (2) this device must accept any interference received, including interference that may cause undesired operation.

This equipment generates, uses, and can radiate radio frequency energy and may cause harmful interference to radio communications if not installed and used in accordance with the instructions. However, there is no guarantee that interference will not occur in a particular installation. If this equipment does cause harmful interference to radio or television reception, which can be determined by turning the equipment off and on, the user is encouraged to try to correct the interference by one of the following measures:

- Reorient or relocate the receiving antenna.
- Increase the separation between the equipment and the receiver.
- Connect the equipment into an outlet on a circuit different from that to which the receiver is connected.
- Consult the dealer or an experienced radio/TV technician for help.

The GPSMAP 276C does not contain any user-serviceable parts. Repairs should only be made by an authorized Garmin service center. Unauthorized repairs or modifications could result in permanent damage to the equipment and void your warranty and your authority to operate this device under Part 15 regulations.

Safety Information

WARNING: The GPSMAP 276C contains a lithium-ion rechargeable battery. The battery used in this device may present a risk of fire or chemical burn if mistreated. Do not recharge out of the unit, disassemble, heat above 140°F (60°C), or incinerate.

WARNING: If original battery must be removed for replacement, dispose of used battery properly. Contact your local waste disposal department for information on proper disposal of lithium-ion batteries. Keep used battery away from children. Do not disassemble and do not dispose of in fire.

WARNING: Only replace with Garmin Lithium-Ion Battery Pack (Garmin Part Number 010-10517-00). Use of another battery may present a risk of fire or explosion.

WARNING: This product, its packaging, and its components contain chemicals known to the State of California to cause cancer, birth defects, or reproductive harm. This Notice is being provided in accordance with California’s Proposition 65. If you have any questions or would like additional information, refer to our Web site at <http://www.garmin.com/prop65>.

CAUTION: Use the GPSMAP 276C at your own risk. To reduce the risk of unsafe operation, carefully review and understand all aspects of this *Owner's Manual*—and thoroughly practice operation using Simulator Mode prior to actual use. When in actual use, carefully compare indications from the GPSMAP 276C to all available navigation sources, including information from other NAVAIDs, visual sightings, charts, etc. For safety, always resolve any discrepancies before continuing navigation.

CAUTION: IT IS THE USER'S RESPONSIBILITY TO USE THIS PRODUCT PRUDENTLY. THIS PRODUCT IS INTENDED TO BE USED ONLY AS A NAVIGATIONAL AID AND MUST NOT BE USED FOR ANY PURPOSE REQUIRING PRECISE MEASUREMENT OF DIRECTION, DISTANCE, LOCATION, OR TOPOGRAPHY. THIS PRODUCT SHOULD NOT BE USED TO DETERMINE GROUND PROXIMITY FOR AIRCRAFT NAVIGATION.

CAUTION: The electronic chart is an aid to navigation and is designed to facilitate the use of authorized government charts, not replace them. Only official government charts and notices to mariners contain all information needed for safe navigation—and, as always, the user is responsible for their prudent use.

WARNING: The Global Positioning System (GPS) is operated by the United States government, which is solely responsible for its accuracy and maintenance. The system is subject to changes which could affect the accuracy and performance of all GPS equipment. Although the Garmin GPSMAP 276C is a precision electronic NAVigation AID (NAVAID), any NAVAID can be misused or misinterpreted, and therefore become unsafe.

MAP DATA INFORMATION: One of the goals of Garmin is to provide customers with the most complete and accurate cartography available, at a reasonable cost. We use a combination of governmental and private data sources, which we identify as required in product literature and copyright messages displayed. Virtually all data sources contain inaccurate or incomplete data to some degree. This is particularly true outside the United States, where complete and accurate digital data is either not available or prohibitively expensive.

Because the Garmin GPSMAP 276C can be used for vehicular navigation, important safety considerations must be followed. Read and observe the following instructions.

WARNING: For use in vehicles, it is the sole responsibility of the owner/operator of a vehicle to place and secure the GPSMAP 276C so it will not interfere with the vehicle operating controls and safety devices, obstruct the driver's view of driving conditions, or cause or personal injury in the event of an accident.

Do not mount the unit over airbag panels or in the field of airbag deployment. Airbags expand with a rapid force that can propel objects in their path towards the driver or passengers, causing possible injury. Refer to airbag safety precautions in the vehicle owner's manual.

Do not mount the unit in a place where the driver or passengers are likely to impact it in a collision. The mounting hardware provided by Garmin is not warranted against collision damage or the consequences thereof.

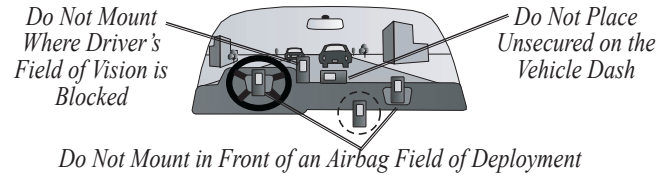

WARNING: When used in vehicles, it is the sole responsibility of the driver of the vehicle to operate the vehicle in a safe manner, maintain full surveillance of all driving conditions at all times, and not become distracted by the unit to the exclusion of safe driving practices. It is unsafe to operate the controls of the unit while you are driving. The driver of a vehicle equipped with a GPSMAP 276C must pay full attention to operation of the vehicle and road conditions while the vehicle is in motion. Failure to pay full attention could result in an accident with property damage and personal injury.

INDEX

A

- Accessories 103
- Accuracy Alarm 69
- Acquiring Satellites 5
- Activate
 - go to 16
 - route 24
 - simulator 11
- Active Route Page 42, 52, 58
 - options menu 52
- Active Track Tab 37, 40
- AC Outlet 2
- Add to Route 21, 24, 26, 30, 63
- Advanced NMEA Output Setup 90
- Alarms 68, 81
 - anchor drag 69
 - arrival 69
 - DSC 54, 57
 - navigation 68
 - next turn 68
 - off course 69
 - persistent 68
 - proximity 36
 - sonar 69
 - system 69
- Alerts. *See* Alarms
- Anchor Drag 69

- Antenna 1, 3, 107
- Append to Route 30
- Arrival Alarm 69
- Arrow Key 7
- Ask Me My Preference 85
- Assign Category 33
- Attention Tone 81
- AutoLocate 3, 5
- Auto Arrange 20
- Average Location 30
- Avoidance Button 86
- Avoids 62, 86

B

- Backlight 3, 80
- Basic Operation 14, 58
- Battery
 - level 4
 - pack 1, 2
 - saver mode 82
- Beeper 81
- BlueChart 106
- Bug Indicator 48

C

- Cable 104
- Calculation Method 85
- Calendar 70
- Calibrate Water Speed 97
- Cards, Data 106

- Care Information vi
- Carpool Lanes 86
- Categories
 - Find Menu 18
 - Waypoint 33, 34
- CDI. *See* Course Deviation Indicator
- Celestial Tab 71
 - hunt & fish tab 74
 - sun & moon tab 73
 - tide tab 71
- Chain Number 110
- Charging 2, 4
- Check Beacon Wiring 109
- Cigarette Lighter Adapter 2
- Cities 18
- Cleaning vi
- Clear
 - Track Log 38
- Clock Alarm 69
- Color Mode 80
- Compass Page 48, 49, 80
 - options menu 48
- COM 1 and COM 2 Tabs 88
- Connecting the Power Cable 2, 104
- Contact Garmin 118
- Count Down or Up 83
- Course Pointer 48
- Create
 - category 33
 - route 21, 22

- waypoints 26, 27
- Current Route Page 64
- Custom Avoids 62, 86

D

- Data Card 44, 106
 - information 20, 79
 - slot 1
- Data Fields
 - changing 78
 - options 116
- Date 83
- Daylight Saving Time 83
- Day View 70
- DB-9 105
- Deactivate 52
- Declutter 46
- Deep Water 69
- Defaults 8, 84
- Delete
 - category 34
 - DSC Call 55
 - DSC directory item 56
 - route 25
 - track log 38
 - waypoint 34, 35
- Depth 84
- Detailed Maps 44
- Detour 63
- DGPS 88, 89, 108

alarm 69
Differential 108, 109
Digital Selective Calling. *See* DSC
Direction Display 84
Display Tab 80
Distance and Speed 84
Distress Calls 54, 55, 56, 57, 113, 114
Drift 69
DSC 54–57, 113–114

E

Edit
 route 23, 24
 waypoints 32
Editing a Waypoint 32
Emergency 113
Entering Data 9, 10
ENTER Key 7
Erase Track Log 38
Exits 18
External Power Source 4
External Voltage
 alarm 69

F

Faster Time 85
FCC 113, 114, 120
Features 8
Field 8
Find 18

 from 18
 from a different location 18, 19
 key 7
 menu 16, 20
Finding an Item 18–20
Find Current Location 3
Find Menu 18
Fishing 74
Fish Symbols 96
Flasher 98
Following an Automotive Route 64
Fuel Flow 25

G

Getting Started 1
Going to a Destination 15
Go To 32
 distress call 56
 history 19
 point 15
 position report 56
GPS
 learning about 108
 off/on 5
 page 6
GRI Chain 111
GSD 20 91
GSD 20 Sounder Module 91
Guidance Tab 86

H

Heading 87
Highways
 avoid 86
Highway Page 80
 page layout 51
 setup 51
Hunt & Fish Tab 74

I

Icons 80
Identifier 113
Information Page 20, 46
Initialize 3, 108
Interval 40
Invert 52
IN Key 7
Item Details 20

K

Keypad 7

L

Language 81, 82
Legs, Track 40
Limited Warranty 119
Lithium-ion Battery 1, 2, 120
Local Time 83
Location 6, 28
Location Format 87, 112

Log Filter 75
Longitude 116
LORAN TD Setup 110
Lost Satellite Reception 5

M

Magnetic Variation 87
Main Menu
 alarms tab 68
 celestial tab 71
 display tab 80
 GPS tab 4
 message tab 75
 sound tab 81
Man OverBoard 15, 17
MapSource 106
Map Card 44
Map Data Information 121
Map Datum 112
Map Orientation 43
Map Page 43
 declutter 46
 setup 78
Marine Timer 49
Maritime Mobile Service Identity.
 See MMSI
Marking a Waypoint 9, 26, 27, 28, 31
 underwater 95
MayDay 57, 114
Measuring Distance 47

MENU Key 7
 Messages 116
 Message Tab 75
 Military Time 83
 Mils 84
 MMSI 54, 113, 114
 MOB 15, 17
 MOB Key 7
 Modes 14, 58, 82
 Month View 70
 Moon Information 73
 Move around the Map 45

N

NAV/MOB 17
 Navigate
 route 15, 22
 track 15, 17, 40
 Navigation Alarms 68
 NAV Key 7
 Near
 current route 19, 20
 destination 19, 20
 next 19, 20
 other 19, 20
 New
 altitude 6
 location 6, 11
 waypoint 28, 31
 Next Turn 86

 alarm 68
 NMEA 88, 89, 90, 107
 North Up 6, 43
 No Beacon Signal 109

O

“Off Route Recalculating” Announcement 86
 Off Course 69
 Off Road 85
 On-Screen Button 8
 Options Menu
 opening 9
 using 9
 OUT Key 7
 Overzoom 44

P

PAGE Key 7
 Page Layout 78
 highway 51
 trip computer 67
 Page Sequence 14
 Panning the Map 43, 45
 PC Interface Cable 105
 Persistent Alarm 68
 Plan Route 25, 52
 Plan Trips 70
 Point 70
 Points of Interest 18

Position 108
 Position Mode 43
 Position Report 54–57, 113–114
 Power 2, 3, 104
 connector 1, 4
 key 7
 outlet 2
 Practice Mode. *See* Simulator Mode
 Project Waypoint Location 31
 Proximity 36
 alarms 36
 points tab 35
 waypoint 36

Q

QUIT Key 7

R

Recalculating 86
 Receiver Not Usable 5
 Receiver Status 5
 Receive Satellite Signals 3
 Receiving a DSC Call 56
 Record Tracks 37, 40
 Reference Position 19
 Registration 118
 Reset Timer 83
 Reset Trip Data 53, 67
 Review Route 23
 Road Routing Tab 85
 Rocker Key 7
 Route 24, 70, 108
 add points 24, 30
 create 21–25
 edit 24–25
 leg transition 25
 options menu 25
 preference 85
 RTCM 88, 89

S

Safety Information 120
 Sail Boat Racing Timer 49
 Satellite Acquisition 5
 Save Present Location 26
 Save this Route 66
 Saving the Current Route 66
 Saving Tracks 38, 39, 40
 Scanning for Beacon 109
 Scan for a Frequency 89
 Scroll Bar 8
 Searching for WAAS 108
 Searching the Sky 5
 Search History 19
 Selecting Options 9
 Serial Communications Port 105
 Serial Data Format 88
 Serial Number 1, 118
 Setup Tab
 guidance tab 86

- road routing tab 85
- system tab 82
- timers tab 83
- time tab 83
- units tab 84
- welcome tab 77
- Set an Alarm 68
- Set Date 83
- Set Fuel Flow 25
- Set Speed 25
- Shallow Water 69
- Shorter Distance 85
- Signal Strength 5
- Simulate 6, 11, 12, 82
 - GPS 5
 - navigation 12, 13
- Sonar 91, 92–95
 - adjusting 93–95
 - alarms 69
 - on the map page 91
 - setting up 96, 98
 - understanding 99
- Sound Tab 81
- Speaker 81
- Specifications 102
- Speed Filter 82
- Split Screen, Sonar 95
- Stop Navigation 52
- Storage vi
- Sun & Moon Tab 73
- Switch Modes 14, 58
- System Alarms 69
- System Tab 82
- T**
- Temperature 76, 84
- Text Language 82
- Thermoclines 101
- Tide
 - chart 72
 - information 71
 - station 18, 72
 - tab 71
- Time
 - delay 110
 - format 83
 - offsets 112
 - tab 83
 - zone 83
- Timer 49
- Timers Tab 83
- Toll Roads 86
- TracBack 15, 40
- Track
 - legs 40
 - log 37, 38, 40
 - review page 38, 39
 - tab 37
 - TracBack 39, 40
- Track Up 6, 43
- Transducer 96, 100
- Trip Computer Page 53, 67
 - page layout 67
- Trip Planning 25, 70
- Tuning Beacon 109
- Turn-by-Turn Route 16, 59, 61, 64
- Turn Off Recalculation Announcement 86
- Turn Unit On and Off 3
- U**
- U-Turns 86
- Underwater Waypoints 95
- Units Tab 84
- Unpaved Roads 86
- Usage Mode 14, 82
- USB 88
 - connector 1, 105
 - data cable 105
- User Points Tab 32
- UTC 83
- UTM/UPS 112
- V**
- VHF 54, 113
- View Details 46
- Voice Language 81
- Volume 3, 81
- W**
- WAAS 6, 82, 104, 108, 109
- Warning Page 3
- Waterproof vi
- Water Speed 97
- Water Temp 69
- Waypoint 18, 26, 108
 - categories 33
 - create 26–36
 - edit 32
 - information page 20
 - name 32
 - proximity 36
 - symbol 32
 - transition to next 25
- Week View 70
- Whiteline 94, 101
- Wide Area Augmentation System.
 - See WAAS
- Z**
- Zoom 44

For the latest free software updates (excluding map data) throughout the life of your
Garmin products, visit the Garmin Web site at www.garmin.com.



© Copyright 2004 Garmin Ltd. or its subsidiaries

Garmin International, Inc.
1200 East 151st Street, Olathe, Kansas 66062, U.S.A.

Garmin (Europe) Ltd.
Unit 5, The Quadrangle, Abbey Park Industrial Estate, Romsey, SO51 9DL, U.K.

Garmin Corporation
No. 68, Jangshu 2nd Road, Shijr, Taipei County, Taiwan

www.garmin.com

Part Number 190-00335-00 Rev. B